

ONCE IN A LIFETIME

PEABODY

ONCE IN A LIFETIME ONCE

GOLDEN TORCH

ONCE IN A LIFETIME ONCE

ONCE IN A LIFETIME ONCE

ONCE IN A LIFETIME ONCE

ONCE IN A LIFETIME ONCE

ONCE IN A LIFETIME ONCE

1987-1988

ONCE IN A LIFETIME



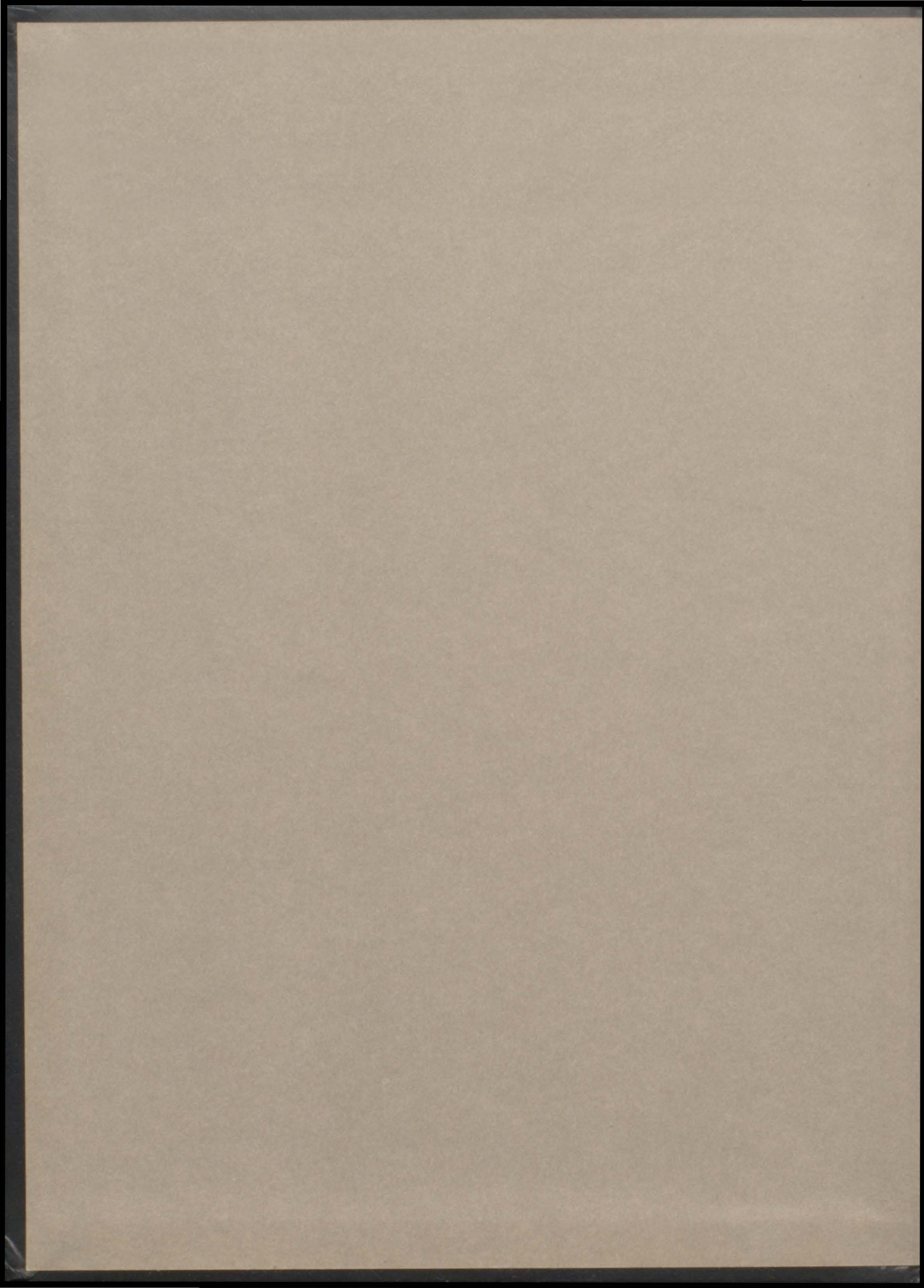

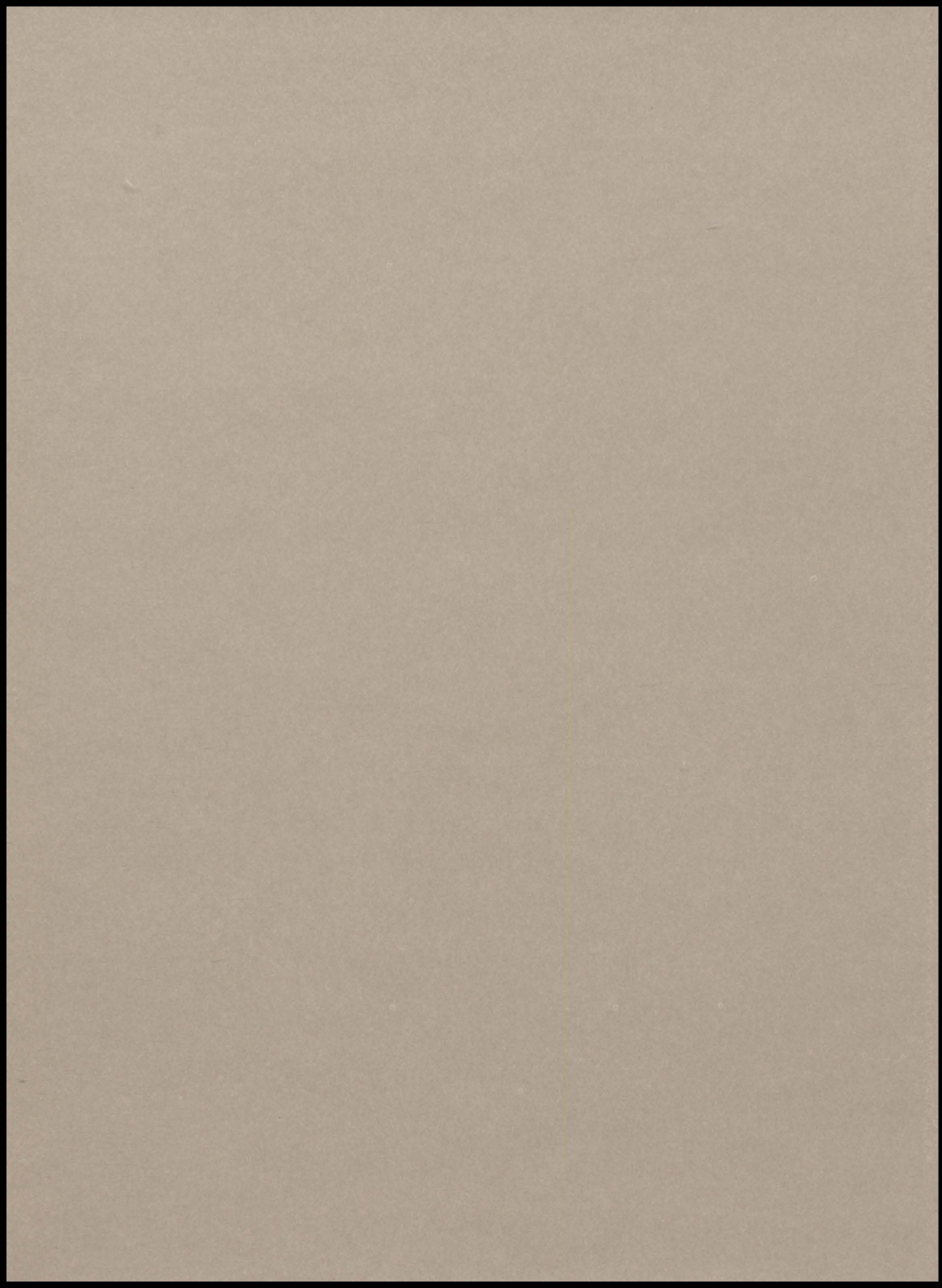

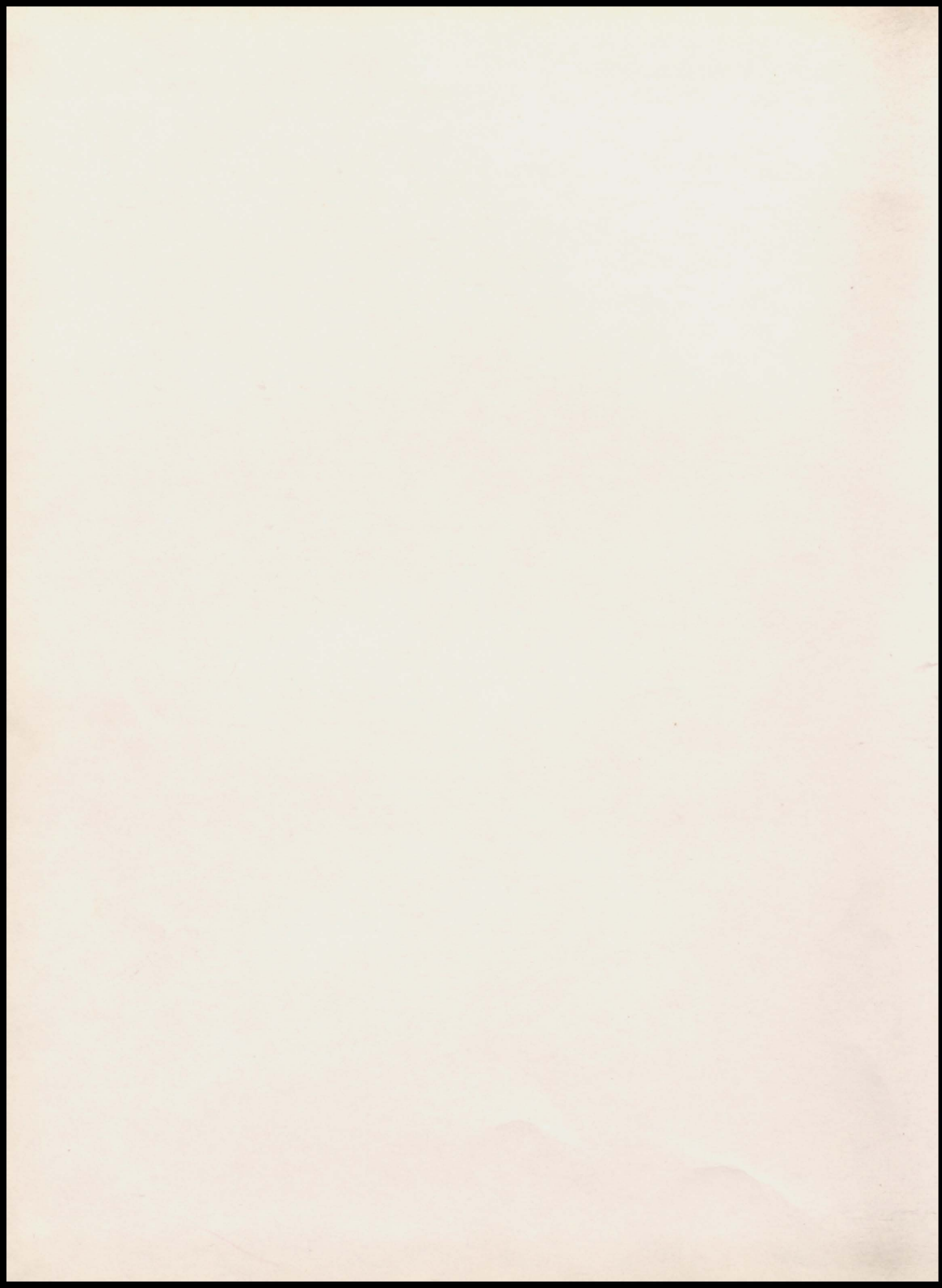

# GOLDEN TORCH '88



PEABODY HIGH SCHOOL

Trenton, Tennessee

Volume 24

Stephanie Goodwin — Editor



## TABLE OF CONTENTS

THE YEAR	Page	5	JUNIORS	Page	57
STAFF		13	SENIORS		65
HONORS		19	SENIOR HONORS		81
SPORTS		25	ORGANIZATIONS		91
BAND		39	ADS		103
FRESHMEN		43	PARENTAL TRIBUTES		142
SOPHOMORES		49	SENIOR DIRCTORY		144

# PEABODY HIGH SCHOOL

Before the 1870's the ideal of public education was not popular in the State of Tennessee. Private schools kept the torch of learning burning. This was all right for those who could afford it, but for those who couldn't it meant they did without an education.

Several private schools were established with varying degrees of success. The largest and most successful of the private schools was Andrew College, located on the site of Peabody. The school was named to honor Bishop J.O. Andrew, whose ownership of slaves caused a rupture in the church before the Civil War. After the closing of Andrew College, the public school directors purchased the Andrew College property for use of the new Peabody School.

Professor McGee became a giant among Tennessee educators. His name became a household word in the state after the publication of his "A School History in Tennessee". It was first published in 1899 after he moved to Jackson; however most of it, if not all, was written while he lived in Trenton.

In 1967 the Student Council of Peabody honored Professor McGee when the group raised funds to repair the monument over his grave in Oakland Cemetery.

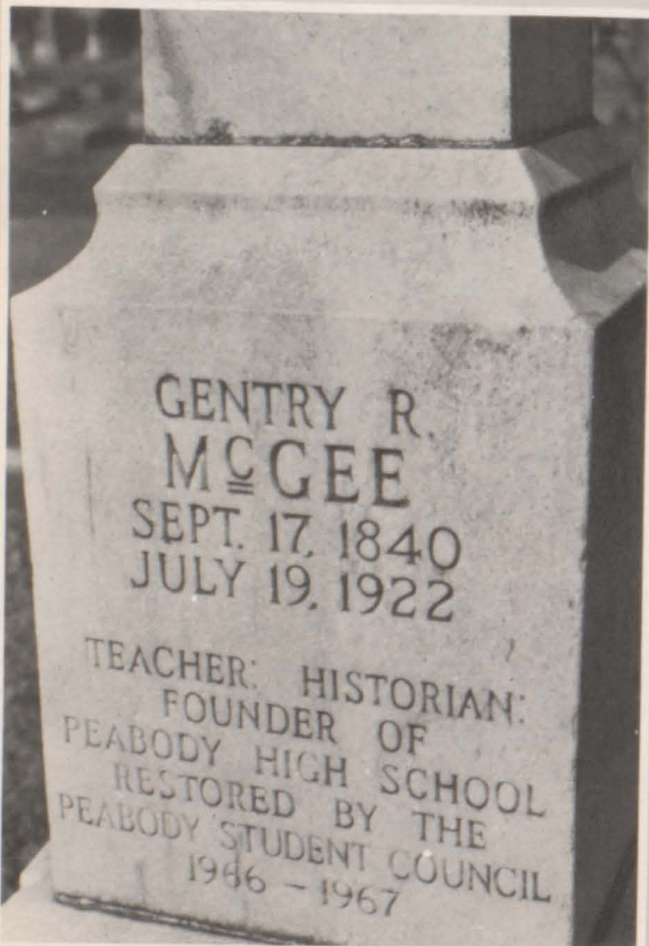

Gentry R. McGee, the professor of the first public high school in the state to receive aid from the Peabody Fund.

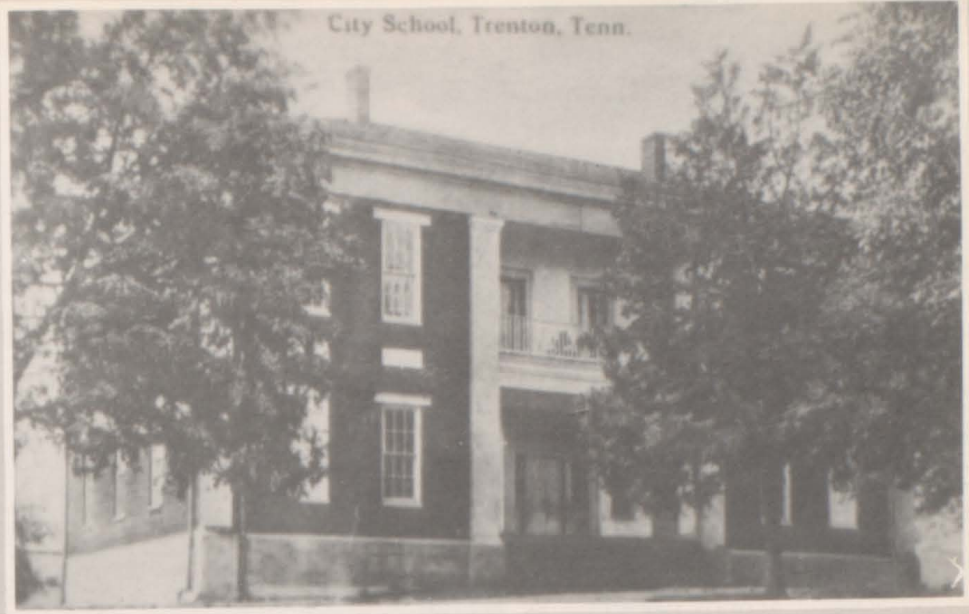

The Andrew College Building used to house the student body of Peabody High School, 1876-1917.



The first class of three members, pictured with Professor McGee, graduated in 1879.

### ALMA MATER

Alma Mater, Hall of Knowledge,  
How we love your name!  
Standing through long years of service,  
Ever gaining fame.

Old Peabody, now and ever,  
We will honor you;  
Long you've stood here ever faithful,  
School our fathers knew.

— Andrew Barksdale  
1942

# 112 YEARS OF HISTORY

# DEDICATION

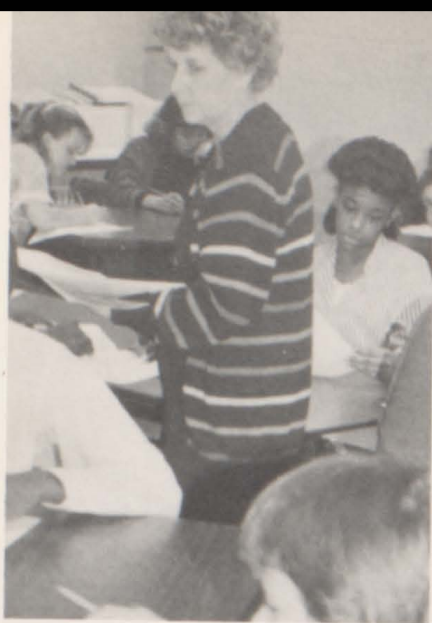

We are proud to dedicate the '88 Golden Torch to Mrs. Nina Cash.

Mrs. Cash has been responsible for many activities in twenty-two years of service. She is accountable for the food for many school activities, and often helps with decorations. These include the "Welcome Back" reception given the staff and banquets. She is the sponsor for the F.H.A., probably the most active organization in school. She is also a freshmen class sponsor.

Mrs. Cash is married to Mr. Billy Cash and has two daughters, Pam and Julie. She lives in Bradford.

We dedicate this annual to her as she is dedicated to helping others.





# THE YEAR

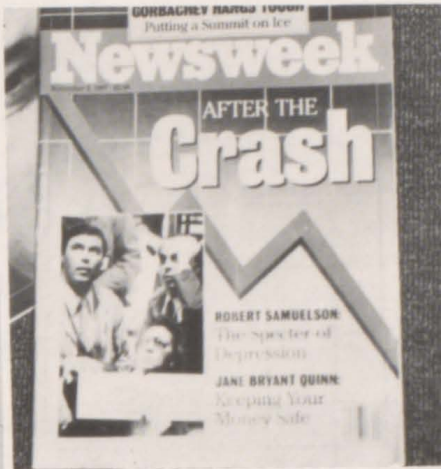
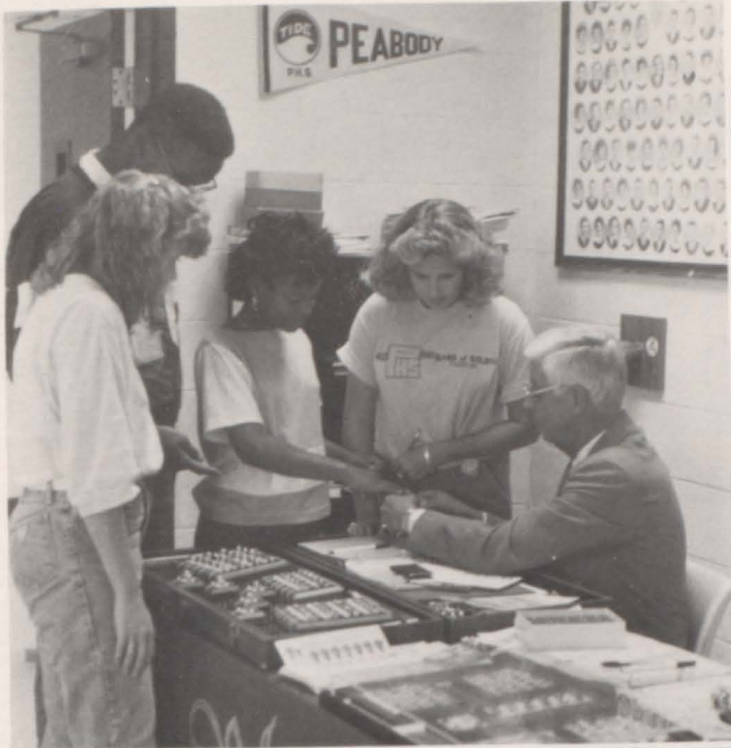

19

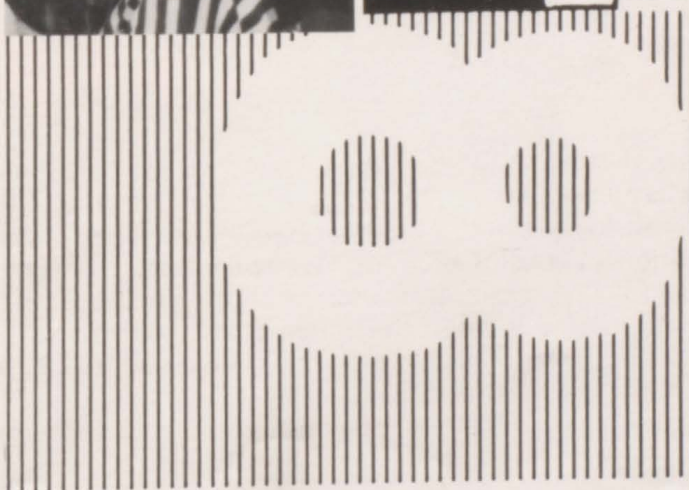

# REGISTRATION

F  
I  
R  
S  
T  
  
D  
A  
Y

With the approach of a new school year, many students became nervous and excited. Registration Day was Aug. 20 with the first day of classes Monday, Aug. 24. The halls were filled with scared and anxious faces. "Where's my next class?" was a common expression among the freshmen.

This year proved to be a great one with the enactment of the Student Council's theme, "Let's Keep Pride in the Tide". One of the largest student bodies ever to pass through Peabody assured everyone that the 1987-88 school year would be one that would only happen "Once in a Lifetime".

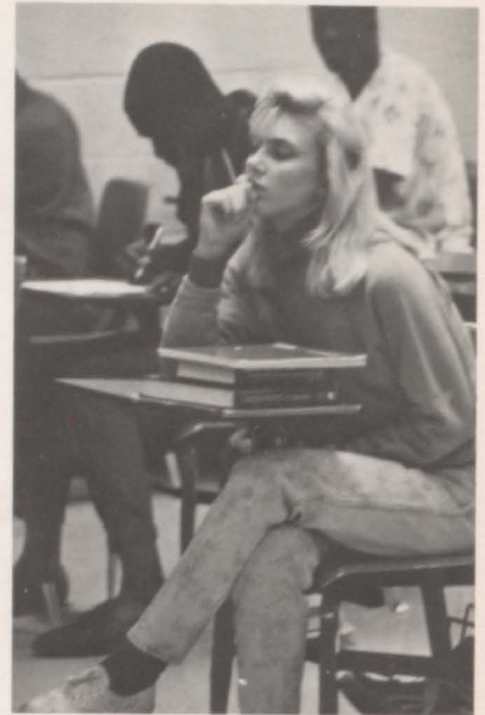

\*Tecumseh Products Co. decided to locate in Trenton.

\*The Minnesota Twins beat the St. Louis Cardinals in the 7th game of the World Series, 4-2.

\*America returned fire in the Persian Gulf after an Iranian missile hit the American-flagged tanker, Sea Isle City.

\*The U.S. watched 18 month-old Jessica McClure hold on for 2½ days until rescuers succeeded in freeing her from a Midland, TX well.

\*Our U.S. Constitution turned 200 years old.

\*Jim Bakker resigned as PTL minister after his tryst with Jessica Hahn was revealed. Bankruptcy followed and the whole debacle caused Tammy Faye to shed more tears.

\*President Reagan and Soviet Premier Mikail Gorbachev met and seemed to make strides toward disarmament.

\*Oliver North admitted on TV that he lied and broke laws in the cause of patriotism.

\*On Black Monday, Oct. 19, 1987, an over-inflated stock market saw the largest single-day loss in history.

\*EVERYONE was wearing Spuds MacKenzie shirts.

\*Gary Hart dropped out and got back in the '88 Democratic Presidential race because of moral improprieties.

\*After 6 years, the marriage of Prince Charles and Princess Di was showing signs of strain.



# "ONCE A DREAM . . .

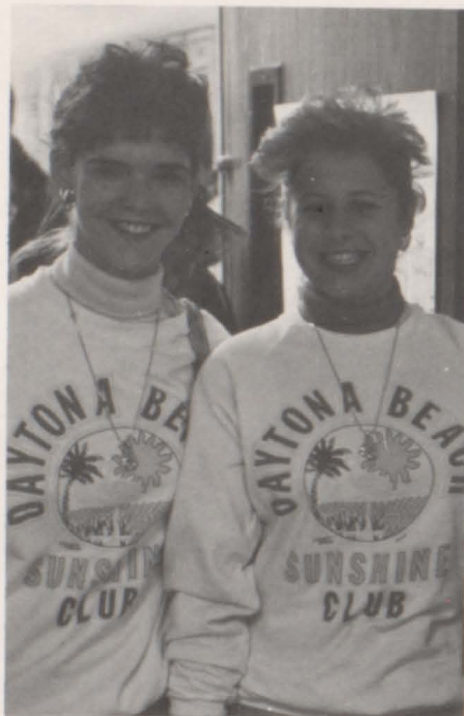

Everyone was filled with exuberant spirits, October 5-9, the week of Homecoming 87! Pulling together as one, each class worked hard for first place on their floats. Friday morning, many spirits were dampened because of rain, but a few hours later they were back up again and ready for a successful Homecoming. The dreams we had built through the week soon became a reality at the ballgame. As black and gold balloons flew through the sky, the Golden Tide ran out with pride. Susan Sisk was crowned Homecoming Queen and the seniors won first place on their float.

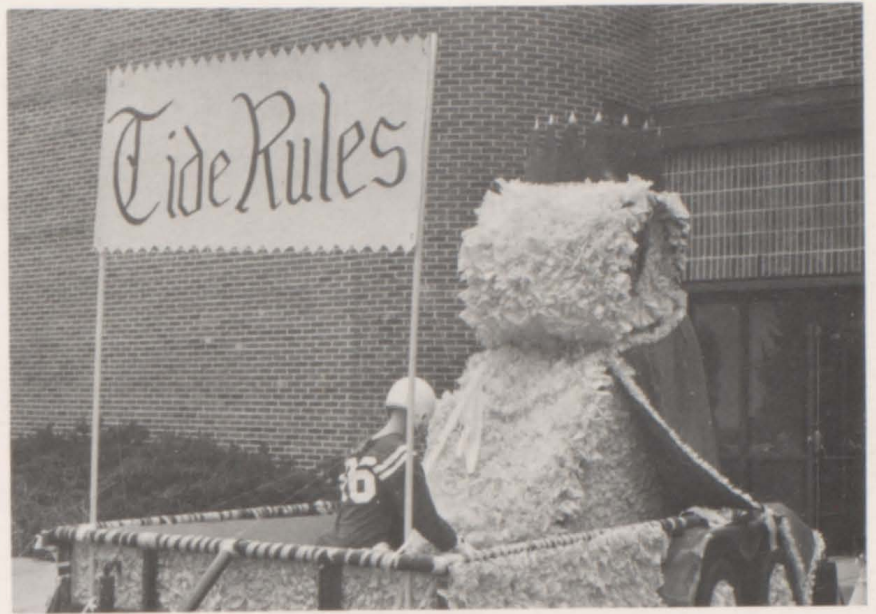

First Place Display — Seniors





Juniors — Fourth Place Display



Freshmen — Second Place Display

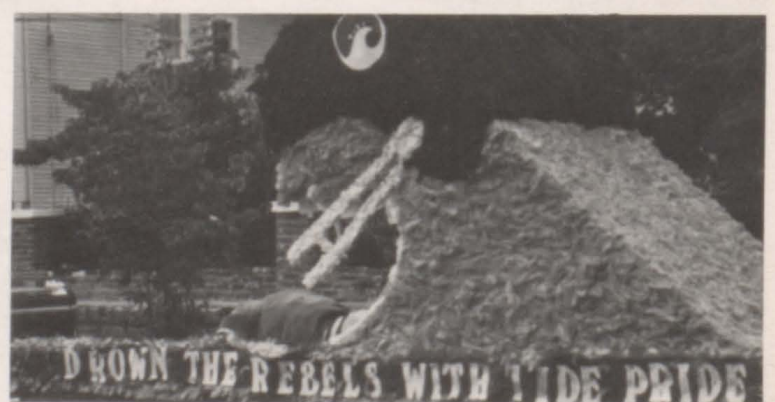

10 Sophomores — Third Place Display

# ... NOW A REALITY



Queen — Susan Sisk



After an exciting game with the Obion County Rebels, everyone was ready to dance the night away. Golden balloons filled the VFW while T & D Entertainment blasted our favorite songs. Homecoming '87 was special ... it happened "Once in a Lifetime," and we will never forget it.



Mr. Bill Manning, Commissioner of Veteran Affairs, spoke to us on Veterans' Day, November 11, 1987.

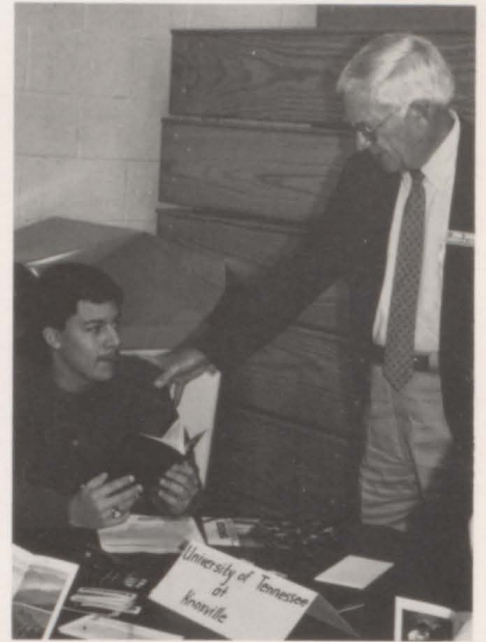

Thursday, Oct. 29, 1987 College/Career Day was held with many business, colleges, and Armed Services represented.

C  
a  
r  
e  
e  
r  
D  
a  
y



And Assemblies



# ONCE THIS WAS OUR STAFF



19

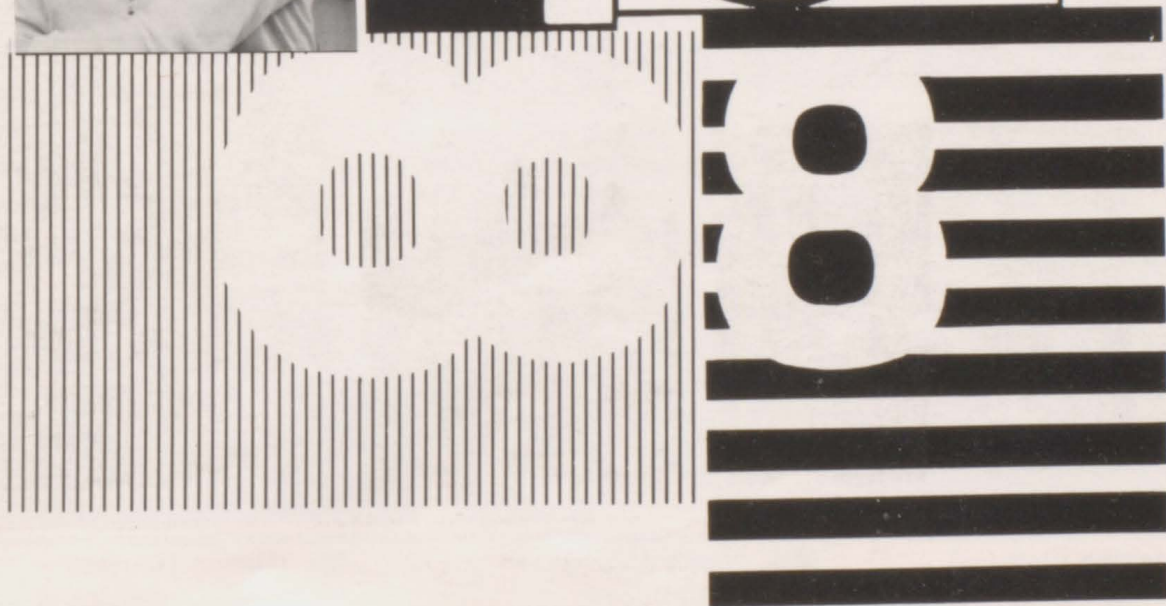

OUR PRINCIPAL'S MESSAGE

The theme for our annual, "Once in a Lifetime", is very appropriate for one's high school years. These are truly "once in a lifetime" experiences. To some this is sad, because it means that once the experience is over, it will never come again. To me, "once in a lifetime" denotes a great opportunity — an opportunity waiting to be seized by you. I sincerely hope that the lessons you learn and the friendships you develop during your "once in a lifetime" experience will last throughout your life. If your choices have been wise ones, the memories you carry with you will be positive and long lasting.

*Sam Miles*



Mrs Martha Crim  
Secretary



Mrs. Nancy Gradisher  
Receptionist



Ms. Glenda Houston  
Guidance Counselor



Mrs. Donna Carr  
Special Ed. English;  
Drama

Mrs. Nina Cash  
Home Ec. I & II;  
Adult Living

Mrs. JoAnn Chilcutt  
English I; V.I.P.  
English

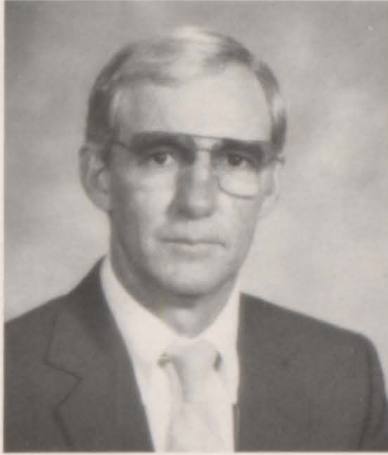

Mr. Fred Culp  
U.S. History;  
Sociology

Mr. Fred Davis  
General Science;  
Physical Science

Mr. Jim Dunavan  
Alg. II, Geometry;  
Tennis



Mrs. Vella Elder  
Applied Math; V.I.P.  
math; arithmetic

Mrs. Jamie Eubanks  
Resource Science &  
Home Ec.

Mrs. Darlene Fairless  
Girl's Basketball;  
V.I.P. English

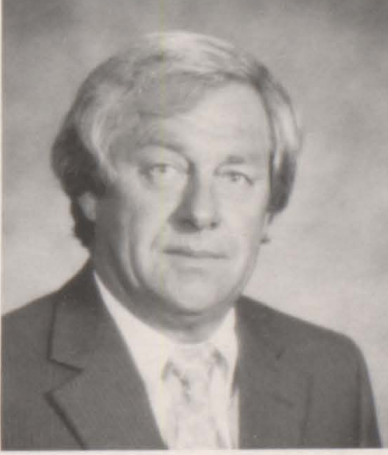
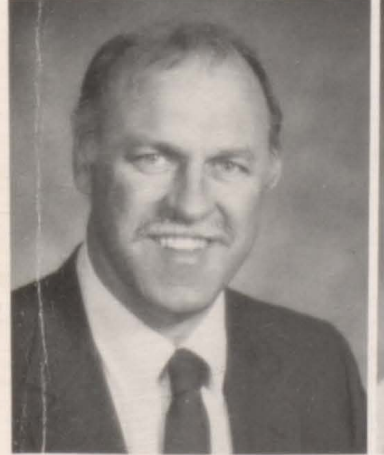

Mr. Harry Furguson  
Boy's Basketball; P.E.

Ms. Sylvia Fron  
Marketing I, II; Co-op

Mr. Frank Gibson  
Biology; Health

Mrs. Sandra Gibson  
English III; Honors  
English III



Mr. Jim Graves  
Health; Alg. I;  
Football

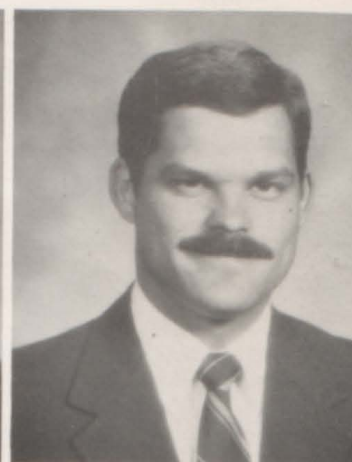
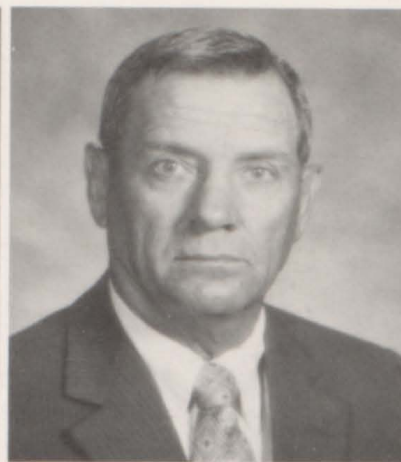

Mr. Mark Gregory  
Agriculture I, II, III, &  
IV

Mrs. Linda Holmes  
Basic Skills Instructor



Mrs. Sylvia Jetton  
Librarian; Annual  
Sponsor



Mrs. Carol Jones  
Jobs For Tenn.  
Graduates

## WHO TEACHES, OFTEN LEARNS HIMSELF.



Among the shoddy work, half-understood,  
The nearly excellent, the almost good,  
You will discover, some rewarding day,  
Some work that unmistakably rates A.



Mr. John Jones  
Advanced Math;  
Computers; Golf

Mrs. Leann Lewis  
Spanish I; II

Mr. Todd Lumley  
Economics; Geography

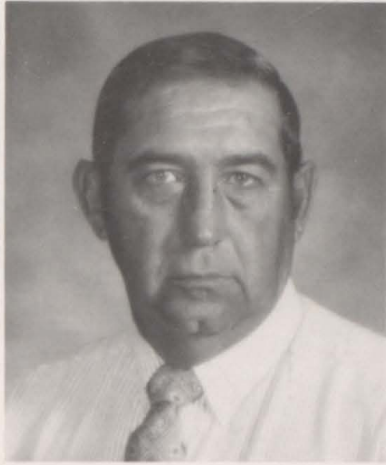

Mr. William  
McKnight  
General Building  
Trades

Mr. Jim Nunley  
Health; World History

Mrs. Judith Reasons  
Accounting; Intro to  
VOE; VOE I, II

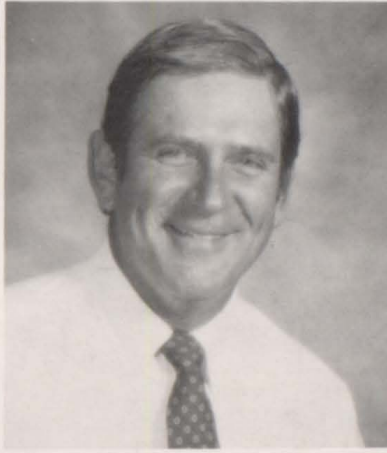

Mrs. Diane Shaw  
Art I, II

Mrs. Patricia Walden  
Special Ed. Math;  
Social Science

Mr. Charles Weems  
Biology; Chemistry;  
Physics

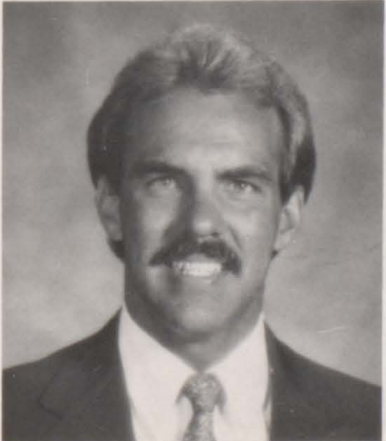

Mrs. Laurel White  
English II; V.I.P.  
English

Mr. David Wood  
Band

Mrs. Charlotte Zarecor  
Honors Eng. IV; Eng.  
IV

Mr. Oliver Johnson  
Custodian

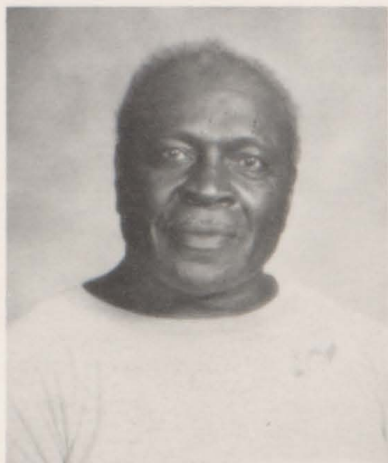

Mr. Bill Reed  
Custodian



Mrs. Leila Wade  
Cafeteria Manager

Mrs. Naomi Jackson  
Cafeteria Staff



Mrs. Brenda  
Johnson  
Cafeteria Staff



Mrs. Rita Scott  
Cafeteria Staff

Mrs. Sunshine  
Scruggs  
Cafeteria Staff



Mrs. Tommie  
Treece  
Cafeteria Staff



# HONORS



19

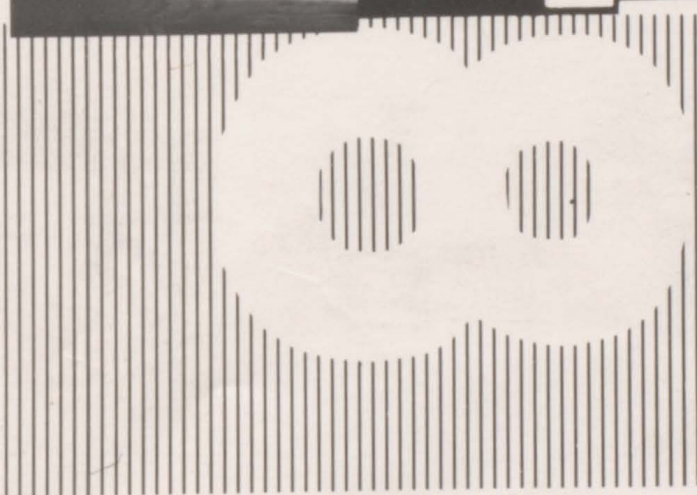

# BETA CLUB



Promoting Mark King for state vice-president and entering Bridget Harper in the talent contest at the State Beta Convention April 8-9 are our goals this year. The annual convention is held in Nashville, and our chapter is always well represented. To make this trip possible, our candy sales have done wonders for the dentists of Trenton.

Donna Grear and Valerie Sweat were recipients of scholarships given in '87, and more deserving students will receive scholarships from our efforts in '88.

Entrance fees to the Academic Decathlon were raised, and our contributions made it possible for Peabody to send a team this year. Other civic services are helping with the American Red Cross Drive and the Lions Club Drive for Patterson Center, a training facility for retarded adults. Since Beta recognizes academic achievement and encourages students to become involved in community service, these activities are well planned to meet our objectives.

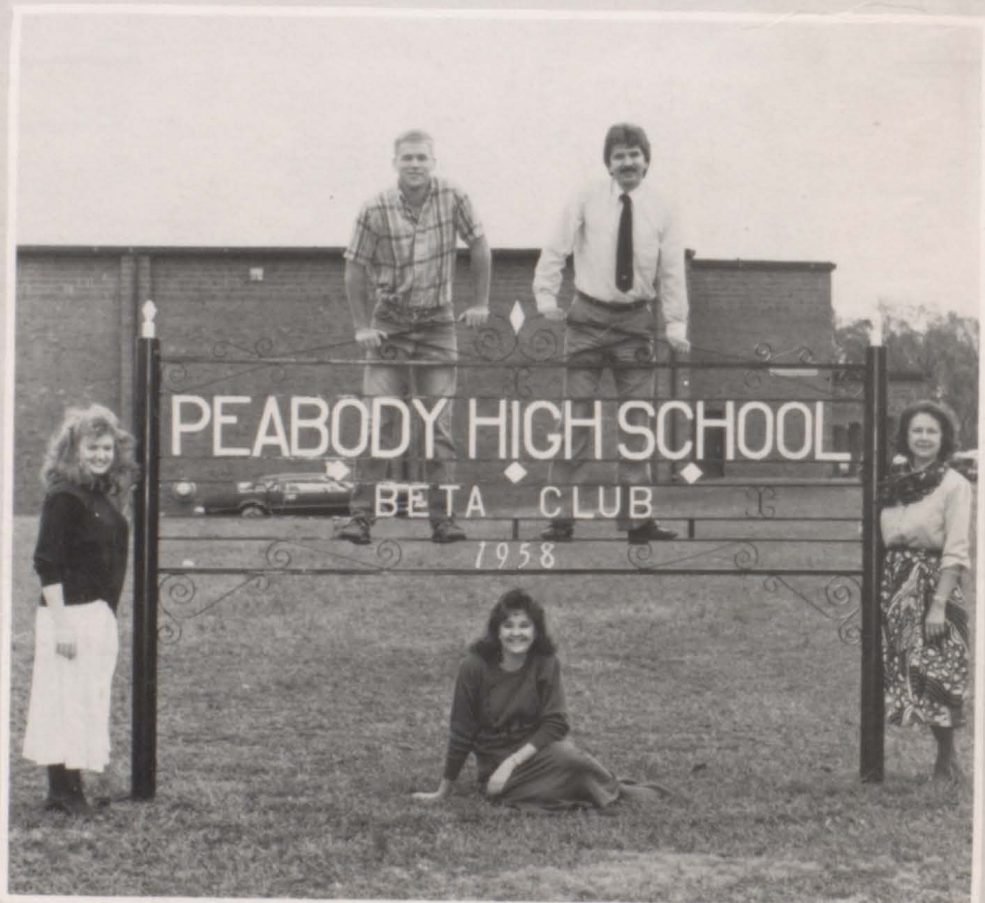

OFFICERS: Bridget Harper, sec./treasurer; Lora Parnell, vice-president; Mrs. JoAnn Chilcutt, sponsor; John Prince, president; Mr. Todd Lumley, sponsor.



# BOY'S AND GIRL'S STATE



DELEGATES: John Prince, Brent Bunch, Harold Brown, Jeff Blankenship, Steve Prince, alternate.



DELEGATES: Stephanie Goodwin, Tricia Clark, Lora Parnell, alternate, Susan Sisk.

Girls' and Boys' State are citizenship training programs that give high school juniors practical experience in the governmental process. While at Girls'/Boys' State, delegates have the opportunity to experience being a part of government, to run for office, to learn that to be free one must undertake the responsibilities of a voter and a citizen. This week incorporates a spirit of mutual sharing and cooperation among young people of Tennessee and gives a week of memories that will last a lifetime.

M  
A  
T  
H

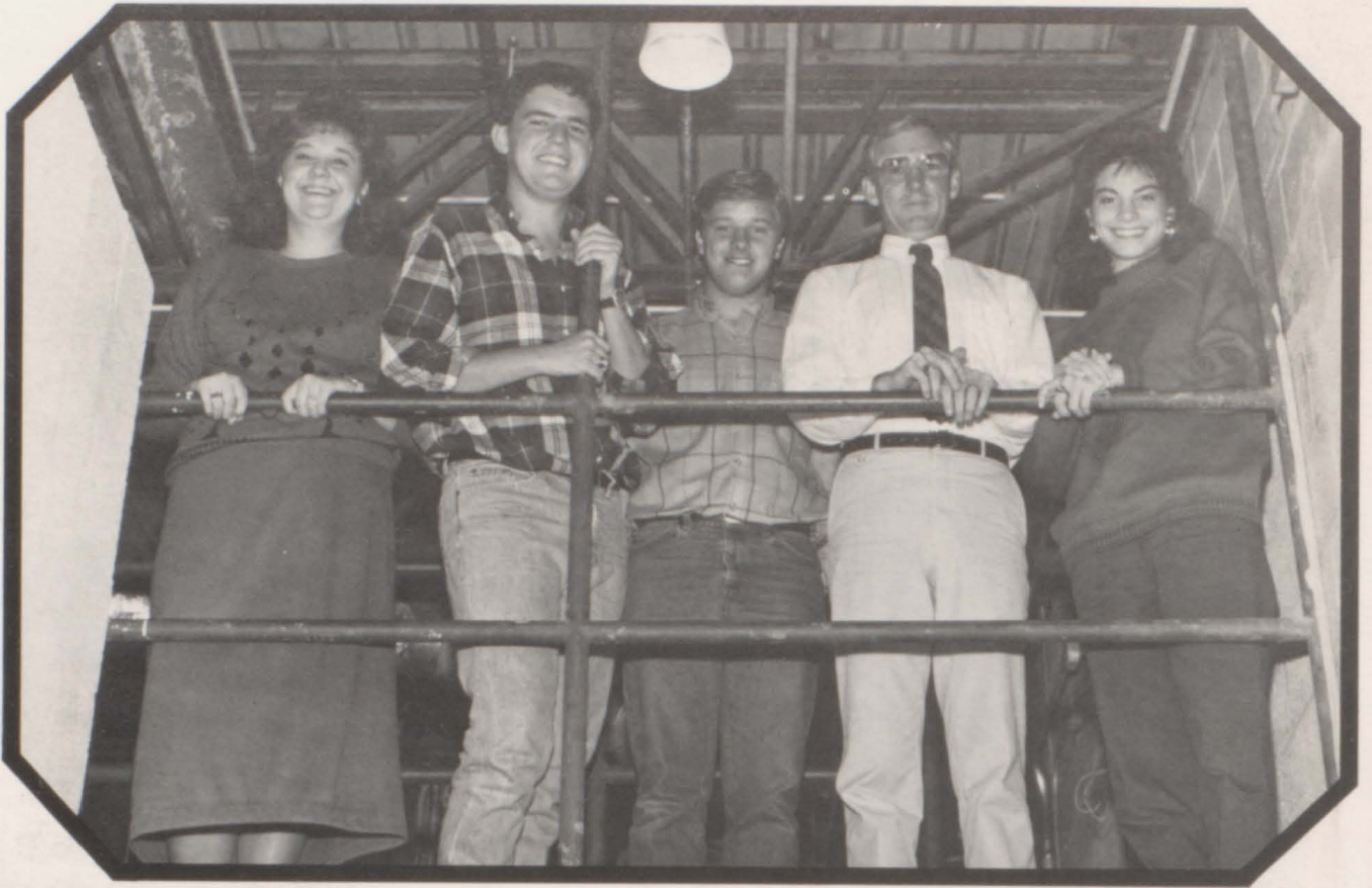

Students invited to join the Math Club must maintain a B average in Algebra II or Advanced Math. They attend presentations made by guest speakers in cooperation with the Science Club.

**OFFICERS:** Lora Parnell, vice-president; Gavin Orgain, treasurer; Jeff Blankenship, president; Jim Dunavan, sponsor; Susan Sisk, secretary.

C  
L  
U  
B



# ACADEMIC DECATHALON



Honor's team: Frank Anthony, Jeff Blankenship, Mark King



Varsity's team: Brad Rainwater, Jason Scott, Robbie Shelton



Scholastic's team: Todd Hensley, Billy Fron, Greg Cannon



Team members: Brad Rainwater, Greg Cannon, Robbie Shelton, Frank Anthony, Jeff Blankenship, Todd Hensey, Billy Fron, Mark King, and Jason Scott

The academic decathlon is a national contest of academic strength. Students who participate study subjects which are more in-depth than those normally offered in high school.

The decathlon was held at Haywood County High School on Feb. 13. Here students were tested on a variety of subjects including math, science, economics, fine arts, and English. The day was capped off by a gathering in the gym where all the schools participated in a rapid question and answer session called the Super Quiz. The state decathlon winner competed in the national contest held in Los Angeles.

# SCIENCE CLUB

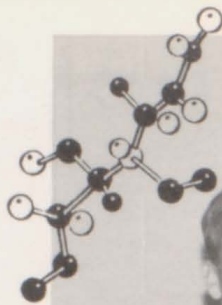

OFFICERS: John Prince, president; Susan Sisk, treasurer; Jeff Blankenship, secretary; Lora Parnell, vice-president.

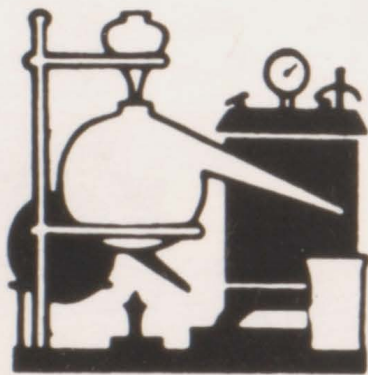

The Science Club is composed of Peabody students who are in chemistry or physics. The senior physics class is the executive body and is responsible for the bonfire at Homecoming.

The purpose of the club is to encourage student interest in science career fields. Throughout the year the club hosts speakers to lecture on various topics dealing with physics, chemistry and natural sciences.



# SPORTS



19

19

00

8

# FOOTBALL



## 1987 GOLDENTIDE

Pride and dignity were the hallmarks of the football team in '87. We all played hard and with a lot of intensity. We showed improvement over last year, but did not reach our goal of going to the state playoffs. Ten seniors gave leadership to our team. Coach Graves always had confidence in us and inspired us to do our best.





SENIORS

SENIORS: Charlton Zarecor, Brent Bunch, John Prince, Cornelius Mayberry, Doug Ganaway, Rob Dublin, Bill Hodges, Greg Cannon, Joel Smith, Todd Hensley.



COACHES

COACHES: Mr. Jim Graves, head coach; Mr. John Jones, line; Mr. Jim Nunley, line; Mr. Ricky Hooker, ends, special teams; Mr. Tim Haney, offensive coordinator.



## FRESHMEN FOOTBALL

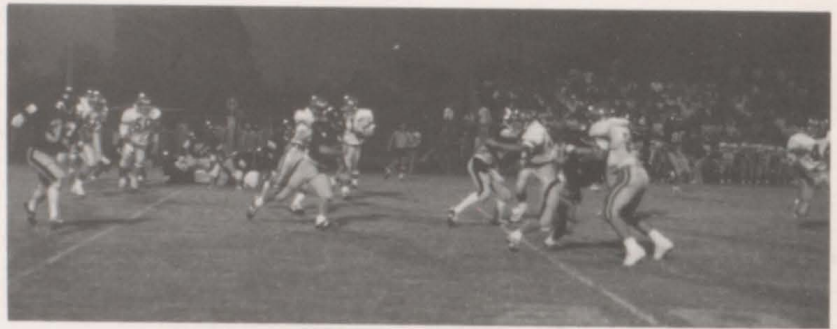



# FRIDAY FEVER!

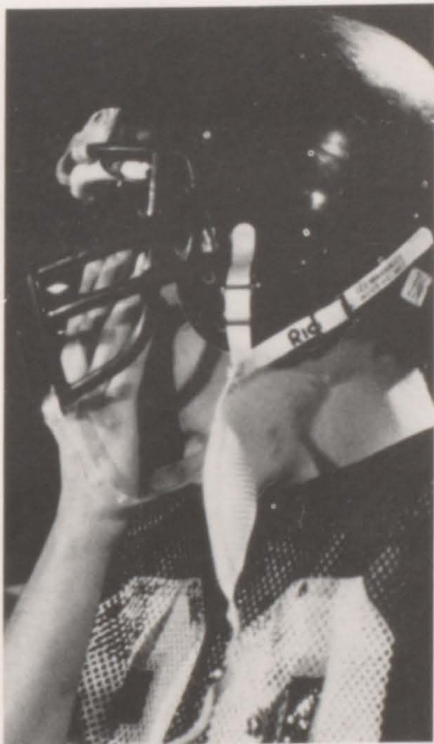

# 1987-1988



Filming crew: Mitzie Branch and Bridget Harper

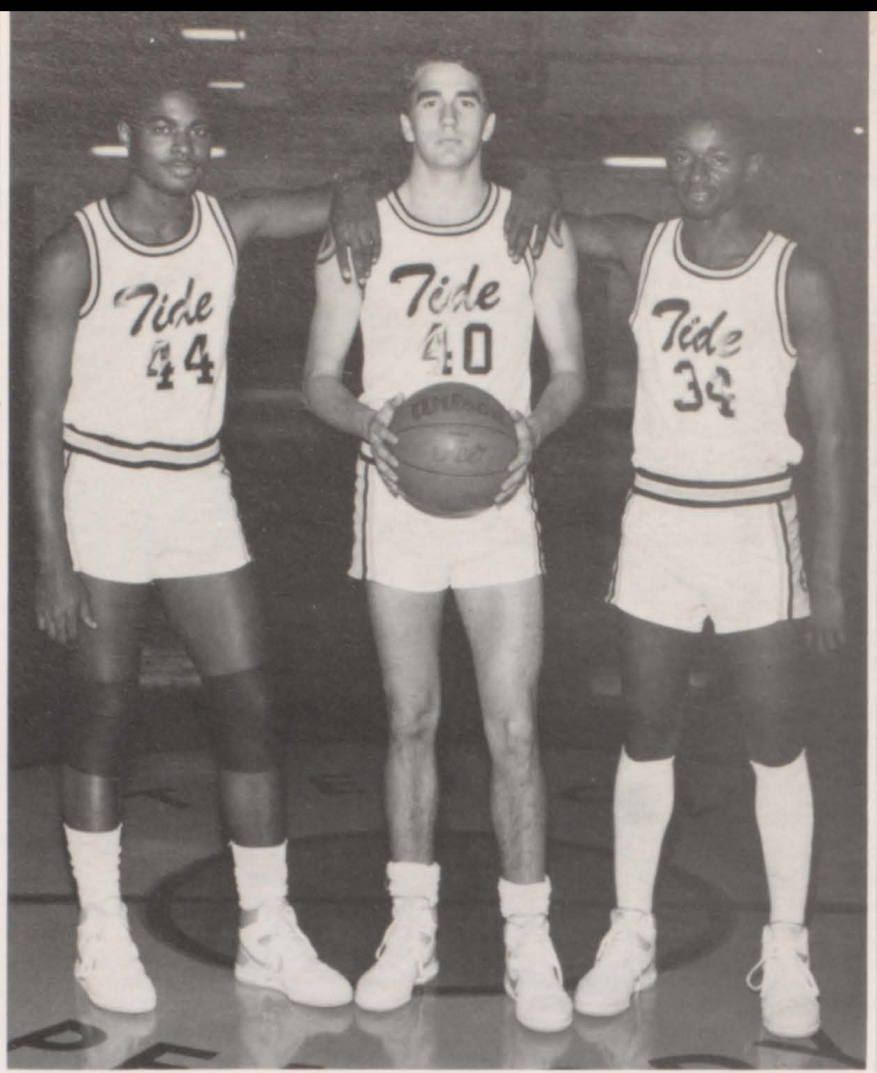

Seniors: Harold Brown, Bill Hodges, Eldred Peterson

## BOYS' BASKETBALL TEAM

Trenton  
vs.  
Bradford

- #34-16 pts.
- #22-19 pts.
- #44-10 pts.
- #30-10 pts.
- #32-6 rbs.
- #52-4 pts.
- #50-4 pts.
- #40-2 rbs.
- #42-4 rbs.
- #20-1 rb.
- #12-1 rb.
- #14-1 ast.
- #10-1 ast.



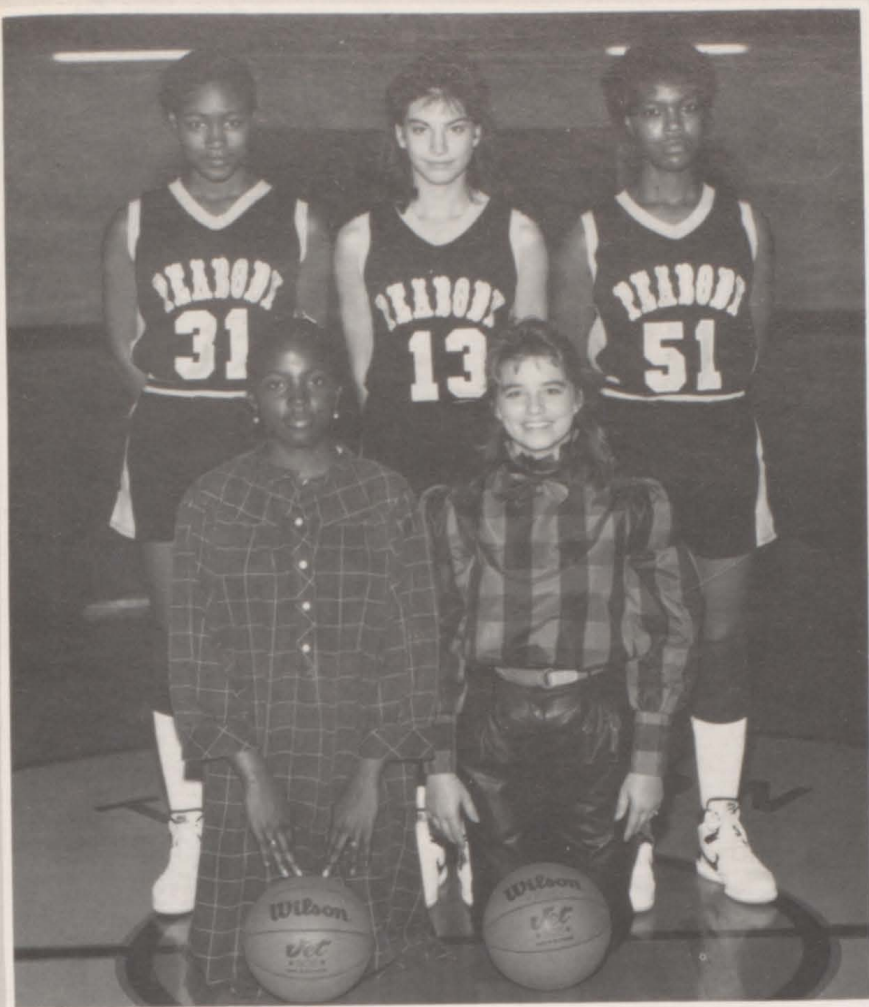

Seniors: Angie Barnett, Mitzie Branch, Teresa Cox, Susan Sisk, and Veronica Welch.

### TRENTON PEABODY GOLDEN TIDE AND TIDETTES' SCHEDULE

Nov.	14	Lexington	Home
	17	Humboldt	Away
	20	Greenfield	Home
	23	Bradford	Home
Dec.	24	Westview	Home
	1	Gibson County	Away
	11	Dyer County	Home
	15	Union City	Away
Jan.	18	Milan	Away
	5	Westview	Away
	8	Humboldt	Home
	12	Milan	Home
	15	Greenfield	Away
	16	Jackson Northside	Home
	19	Bradford	Away
	22	Union City	Home
Feb.	26	Dyer County	Away
	2	Crosett County	Away
	6	Lexington	Away
	9	Gibson County	Home
	12	Clarksburg	Home

# SCORE!

## GIRLS' BASKETBALL TEAM



Trenton  
vs.  
Westview  
#51-12 pts.  
#13-8 rbs.  
#35-16 pts.  
#31-5 pts.  
#53-10 rbs.  
#11-3 pts.  
#21-3 rbs  
#41-2 asts.  
#23-2 pts.  
#15-2 asts.

# CHEERLEADERS

V  
A  
R  
S  
I  
T  
Y



VARSITY CHEERLEADERS: Melissa Wilson, senior; Jill Choate, Stephanie Turner, Stacey Coffman, Denise Lawrence, Andrea Bailey, Elizabeth Coleman, Betsy Arnold





SENIORS: Joel Smith, Greg Rinks, Charlie Elgin, John Prince, Todd Hensley, Greg Cannon, Rob Dublin, Michael Wallsmith.



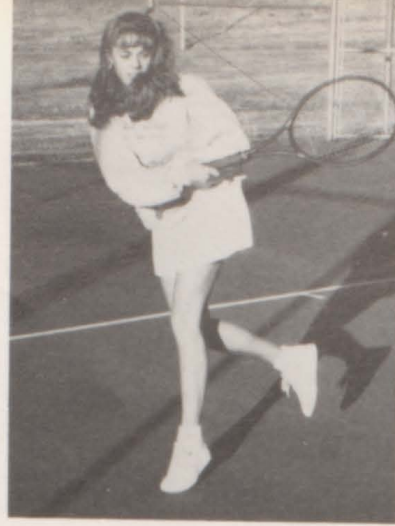

SENIORS: Susanne Coffman, Mitzie Branch, Sonya Bailey, Paula Hickerson, Ruth Ann Gipe, Jim Dunavan, coach, Susan Sisk.



SENIORS: Gavin Orgain, Paul Cromley, Mike Dubrule, Charlton Zarecor, Bill Hodges, and Jim Dunavan, coach.

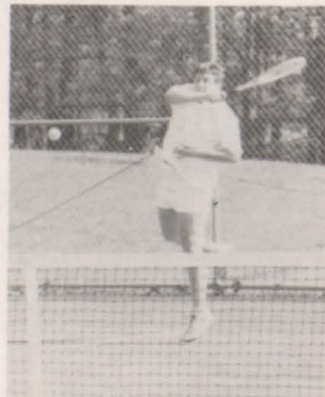



SENIORS: Crystal Coleman, Denise Thompson, Stephanie Goodwin, and Susanne Coffman.

Monk, can't you get it right?

SENIORS: Chuck Thompson, Monk Langston, and Charlie Elgin.



GIRLS



FRESHMEN BASKETBALL

BOYS





# ONE THURSDAY NIGHT

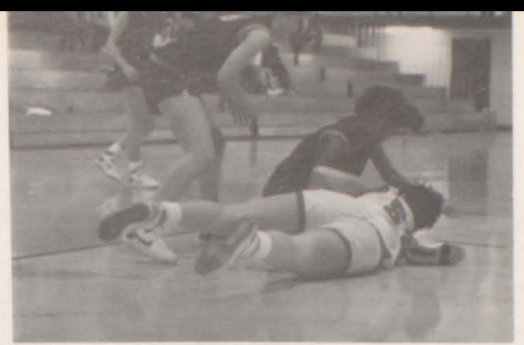
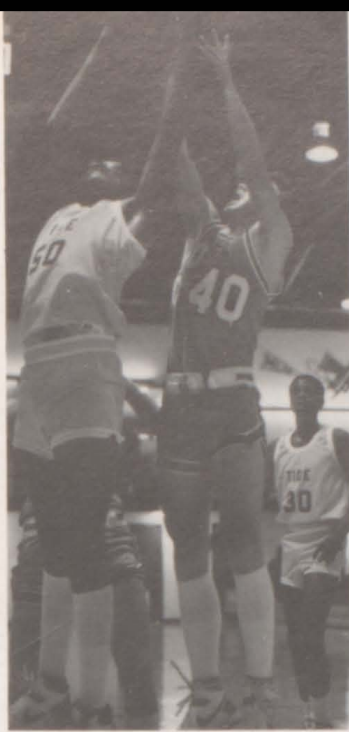
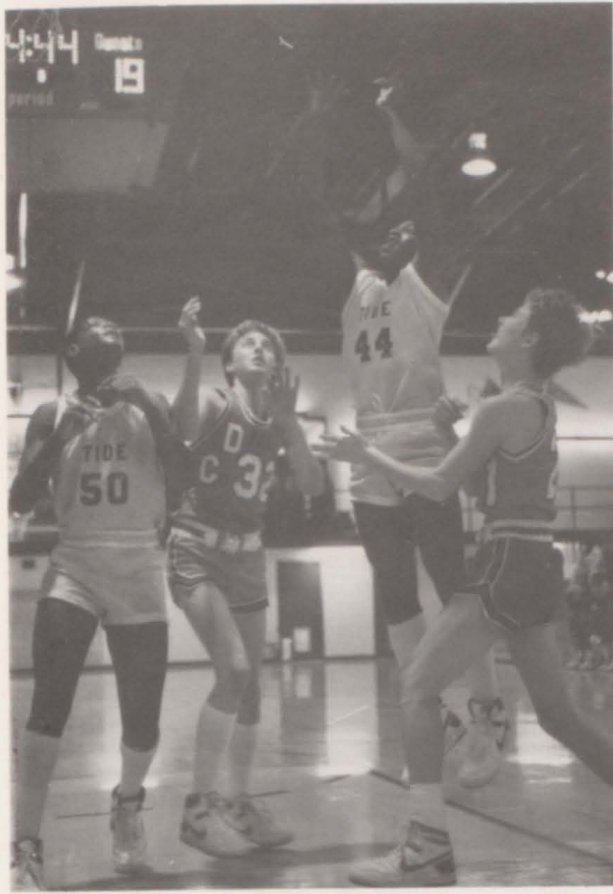

## FRESHMEN CHEERLEADERS



T  
I  
D  
E  
  
P  
R  
I  
D  
E



Heart-breaking finish!



# BAND



19

00

8



The PHS Band of Gold officers are Frank Anthony, band captain; Jeff Blankenship, first lieutenant; Steve Prince, second lieutenant; Tracy Gibson, field commander; Susan Sisk, flag captain; Lisa Warren, co-captain; Sonya Bailey, rifle captain. On Sept. 26, the band traveled to the Milan Invitational and received second place in their class. Tracy Gibson and the auxilliary placed second in the large division. On Oct. 10 in the Gibson County Contest, the band earned first place in their class. The auxilliary placed first, and Tracy Gibson placed second in the large division. At the Music City Invitational in Nashville, Tracy Gibson and the band received superior ratings on Oct. 17. The final contest on Oct. 24 was at Northside High School. Tracy Gibson earned first in the class and also overall. The band received second in their class.



M  
R.  
D  
A  
V  
I  
D  
W  
O  
O  
D



R  
I  
F  
L  
E  
C  
O  
R  
P



S  
E  
N  
I  
O  
R  
S



F  
I  
E  
L  
D  
C  
O  
M  
M  
A  
N  
D  
E  
R

87  
88

M  
A  
J  
O  
R  
E  
T  
T  
E  
S



# THE PEABODY BAND OF GOLD



S E C T I O N  
B R A S S



F L A G  
C O R P



Mr. Glen Gately  
— asst.



S E C T I O N  
P E R C U S S I O N

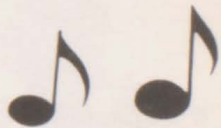

S E C T I O N  
W O O D W I N D



# HAPPY HALF-TIMERS



ONCE WE WERE FRESHMEN



19

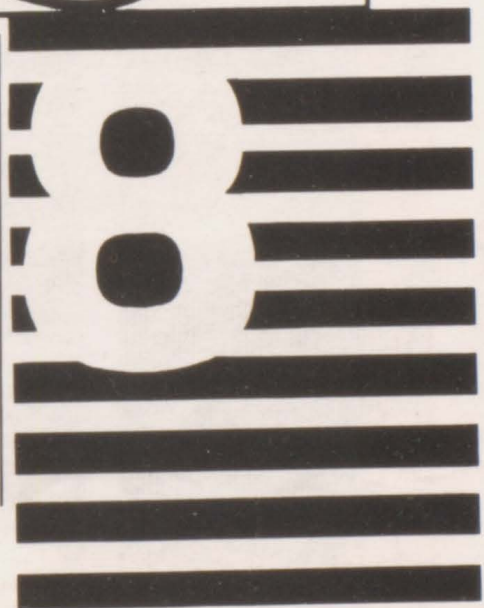
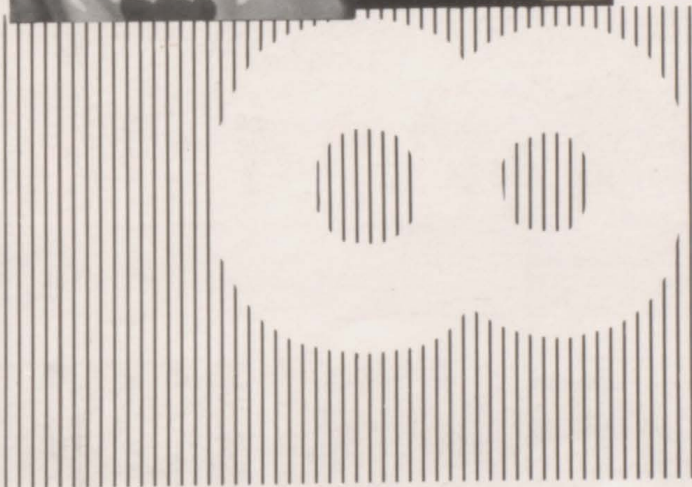

# FRESHMEN CLASS

This is a time when we can get off to a good start for our four years of high school, although we hate the things that are sometimes said about freshmen. The teachers here care, and they make us understand when we don't know what we're doing. We are proud to be freshmen. We have shown that we can work together to accomplish things no one ever thought we could. If we maintain our school spirit and determination, the Class of '91 has the potential to be the best class to pass through P.H.S.



**CLASS OFFICERS:** Jenny Howell, treasurer; Steve Nunley, president; Marcus Wallsmith, vice-president; Melinda Carter, secretary.

Jimmy Abercrombie  
Ron Allen  
Chris Anderson  
Stefanie Anderson  
Clint Arnold

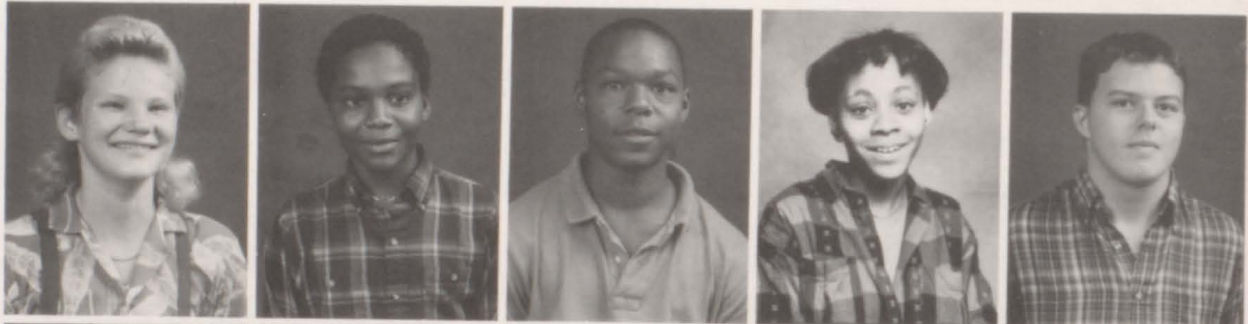

Jennifer Ayers  
Pete Ball  
Sid Barton  
Tori Bechtel  
James Bickford



Sara Bickford  
Beth Bobbitt  
David Brown  
Howard Bryant  
Timmie Bryant

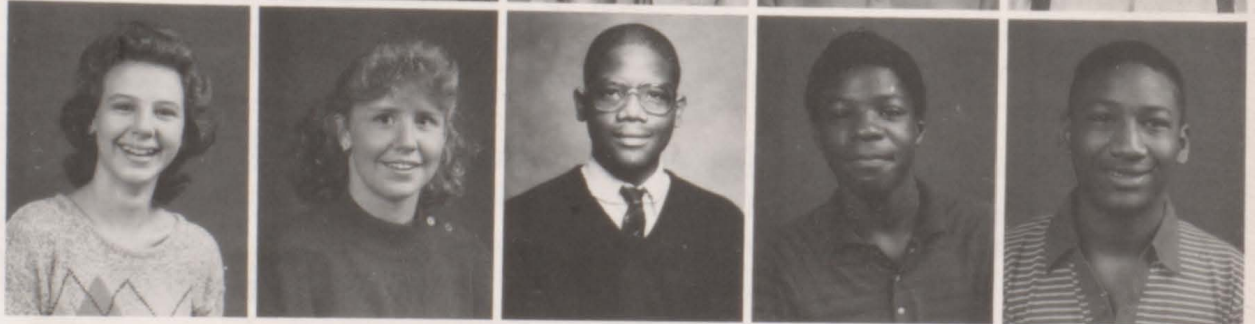





Ashley Carson  
Melinda Carter  
Mike Casteel  
Dianna Chartrand  
Derek Cook



Chris Corbin  
Hayley Crocker  
Jason Cross  
Michelle Dabbs  
Brandy Davis

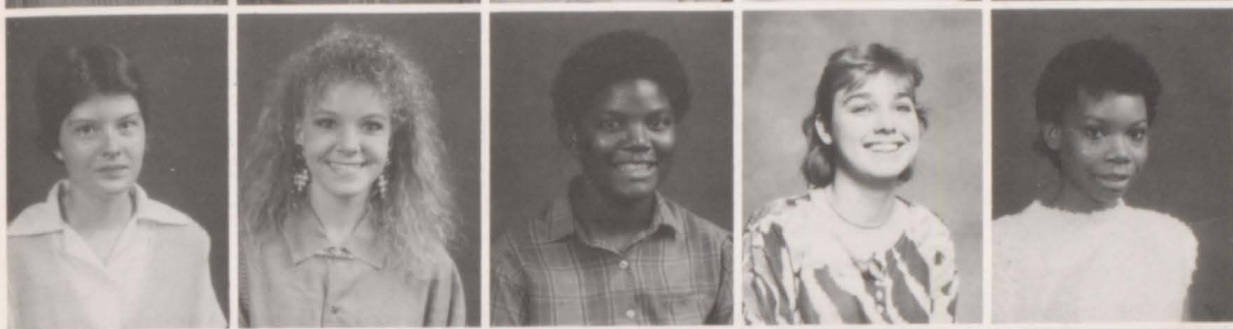

Sandra Denton  
Stacey Denton  
Christa Dodd  
Tracy Dunn  
Jessica Easley



Tonya Ferguson  
Allen Garner  
Rusty Garison  
Chris Gore  
Bobby Graves

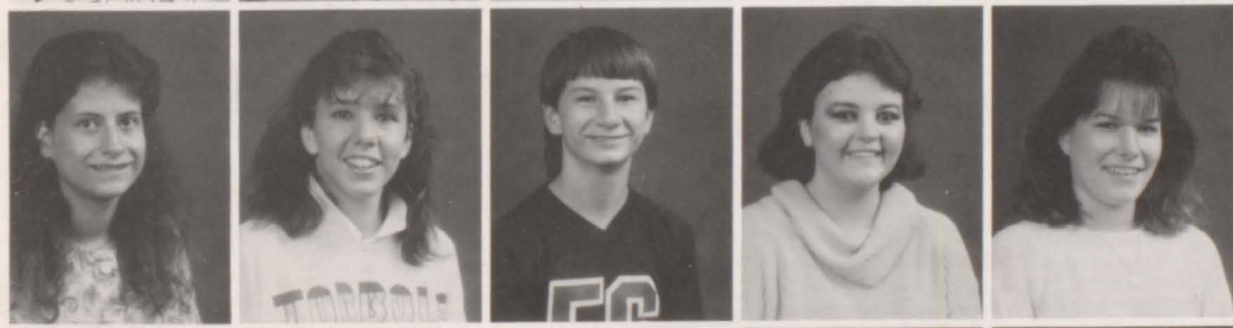

Sophia Graves  
Julie Griffin  
James Grimes  
Angela Hamm  
Tiffany Harper

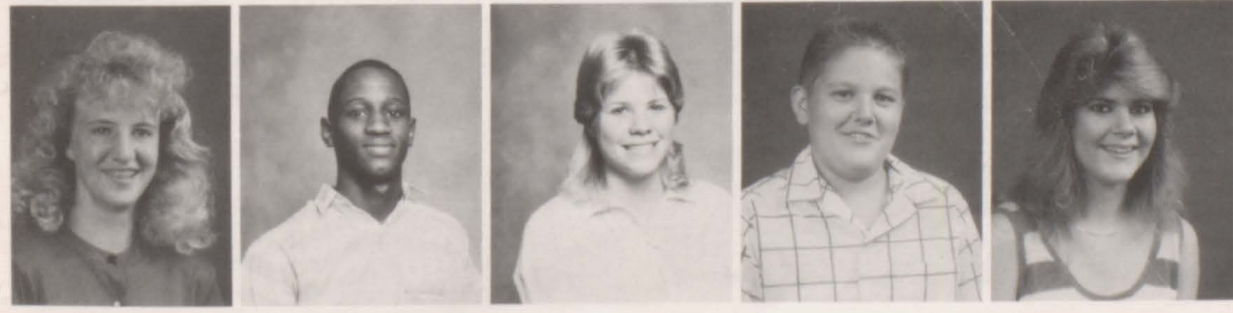

Angela Harris  
Keith Harris  
Meg Hartfield  
Steve Hendrix  
Amy Hinson

Jason Hopkins  
 Jenny Howell  
 Teresa Howell  
 Kimani Hunt  
 Joseph Jarett



Teresa Johnson  
 Davy Jones  
 Scott Jones  
 Tracy Keeton  
 Chris King



Bubba King  
 Tracey Lawrence  
 Sonny Leach  
 Dion Lee  
 Rodney Lowery



Tina Lowery  
 Tommy Luten  
 Brad Mackin  
 LaTasha Mays  
 Joseph Mitchell

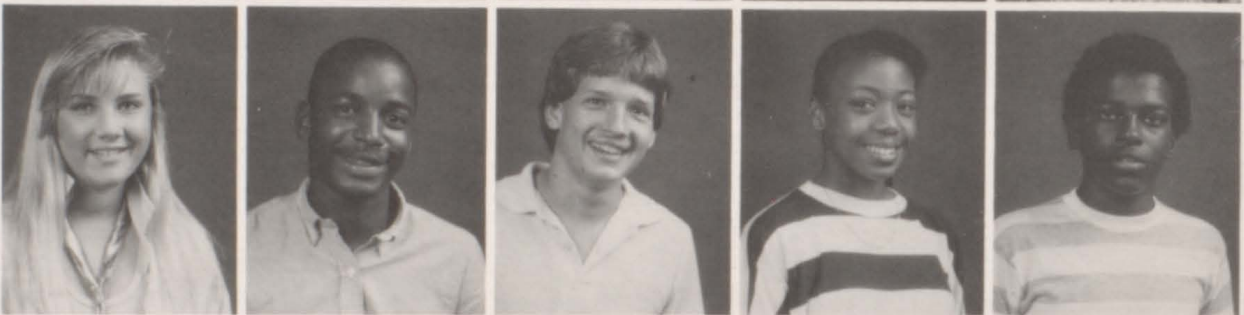

Sandra Mitchell  
 Steve Nunley  
 Mark Oliver  
 William Palmer  
 Roxie Partin

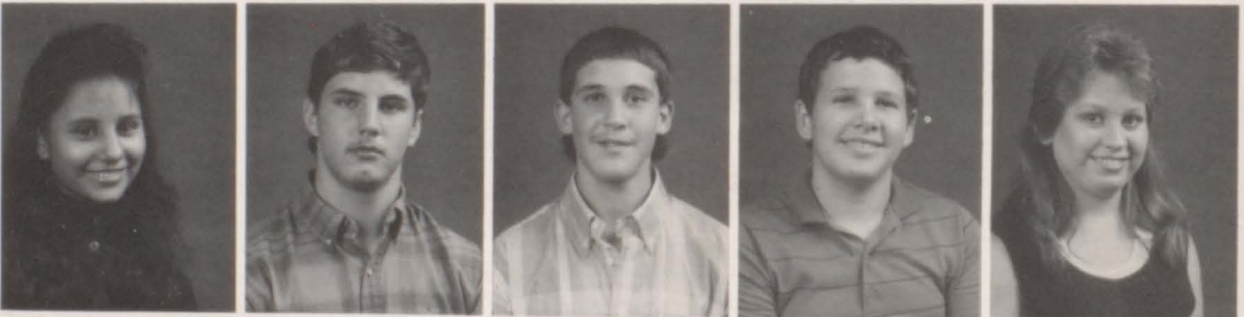

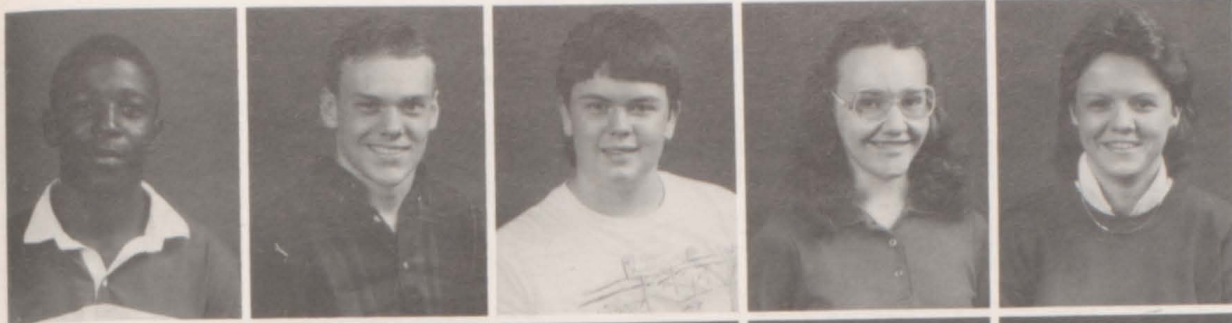

Conchas Powell  
 Brian Pulley  
 Jeff Rainwater  
 Donna Reasons  
 Sandi Redmond



Tonya Richardson  
 Tracy Riley  
 Kenneth Robbins  
 Michael Sanders  
 Jason Scott



Angela Smith  
 Tara Smith  
 Jennifer Speer  
 Raymond Spinks  
 Sean Stark

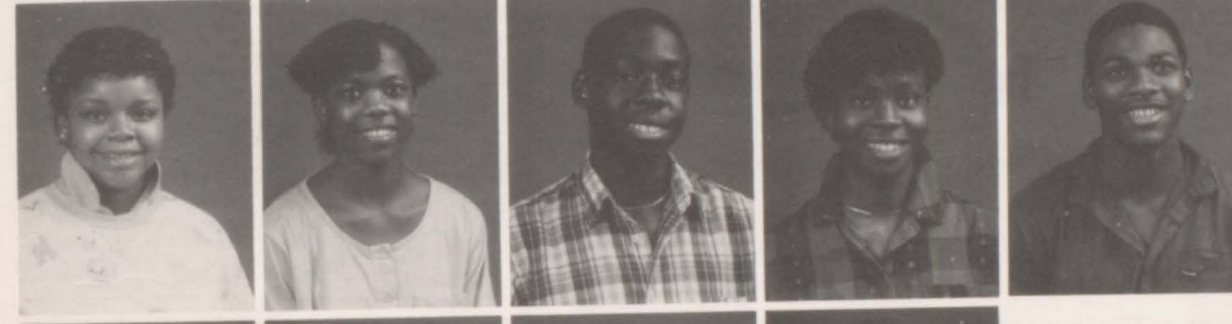

Felicia Summers  
 Tracy Taylor  
 Sharriod Thomas  
 Lashell Vasser  
 Chris Wade

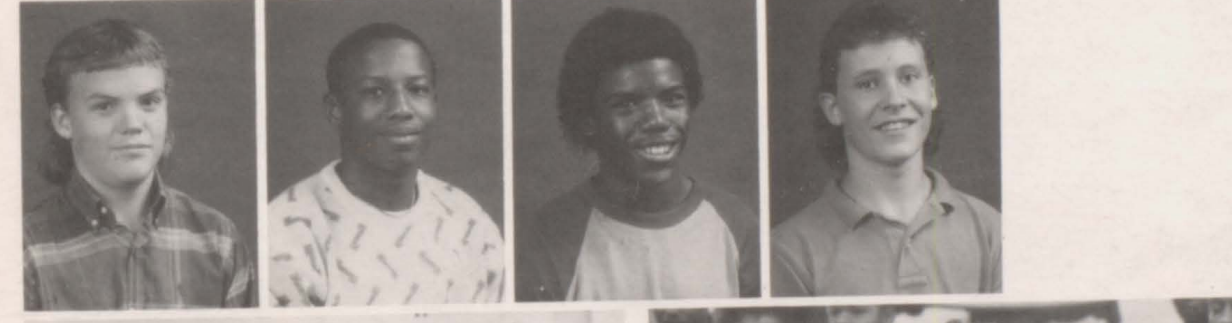

Marcus Wallsmith  
 Jerry Ward  
 Terry Williams  
 Tommy Woods



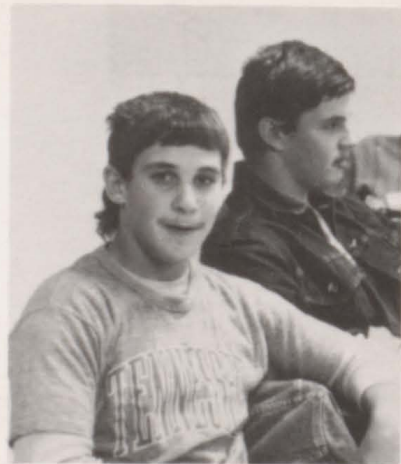
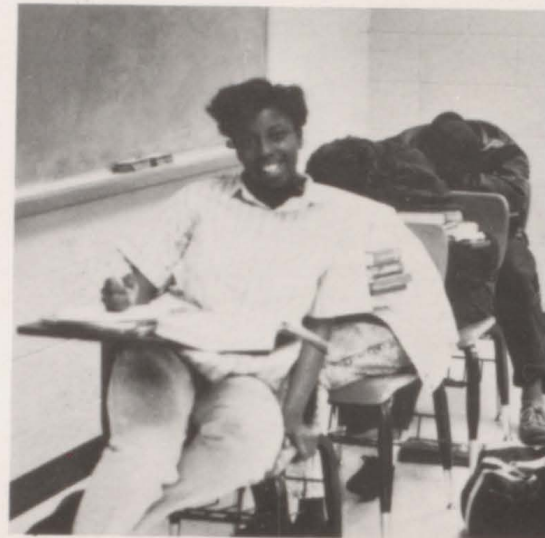
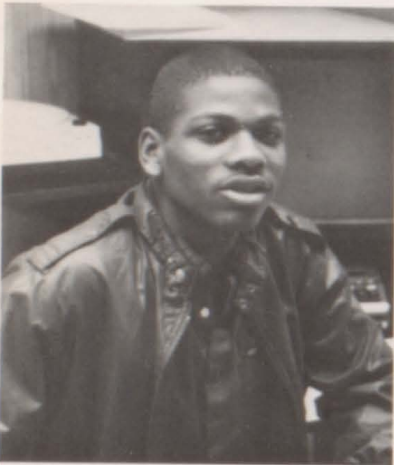

ONCE WE WERE **SOPHOMORES**

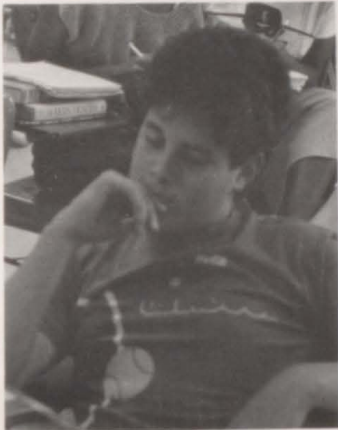

**19**

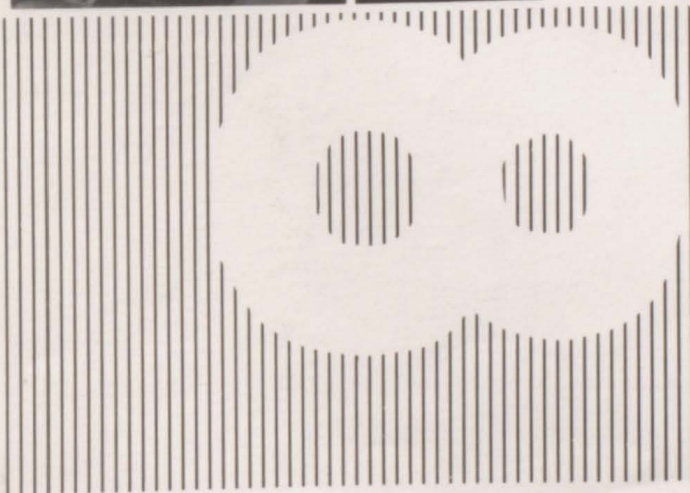

# SOPHOMORE CLASS

Although some people refer to the sophomore year as the Dreaded Sophomore Slump, the Class of '90 is a very exciting class. Our sophomore year has gotten off to a good start, thanks to our class leaders and sponsors. Sometimes things don't go the way we want, but we always hold our heads high and keep smiling. We have high goals, and we've matured a lot. We have grown from our childish ways, and we are striving to be the best.



**CLASS OFFICERS:** Chas Weems, vice-president; Andy Thompson, treasurer; Carla Litton, secretary; Walter Dickson, president.

Mark Agnew  
Felicia Albea  
Betsy Arnold  
Robin Ayers  
Andrea Bailey

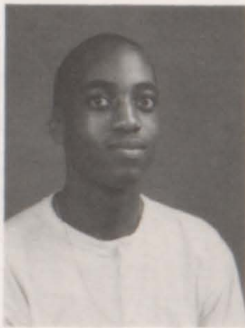

Tammy Barber  
Pete Beavers  
Melissa Bellew  
Tony Blackburn  
Jenny Blasen



Bobbie Brown  
Christina Brown  
Jerry Buchanan  
Tonya Bufford  
Brian Casey

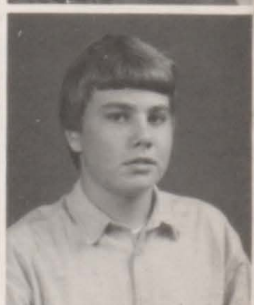
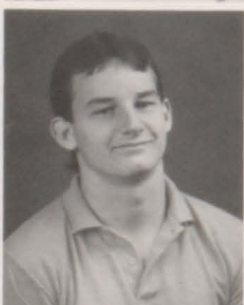

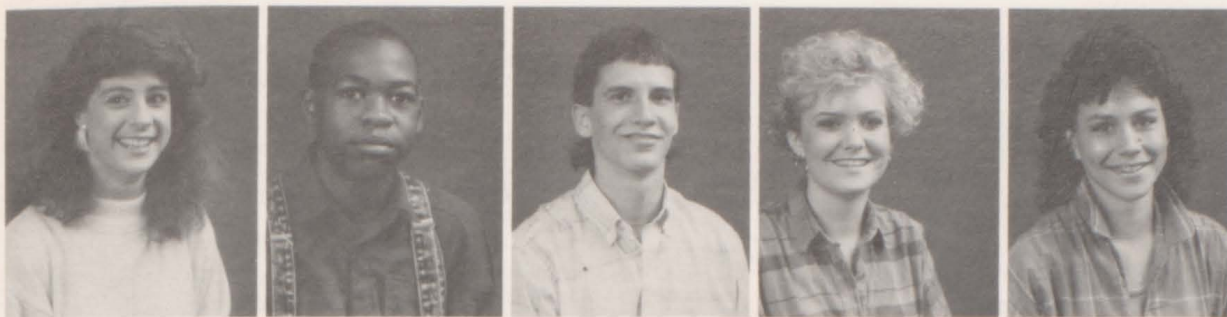

Jill Choate  
Junior Clark  
Jeremy Cloyd  
Stacey Coffman  
Jennifer Cole

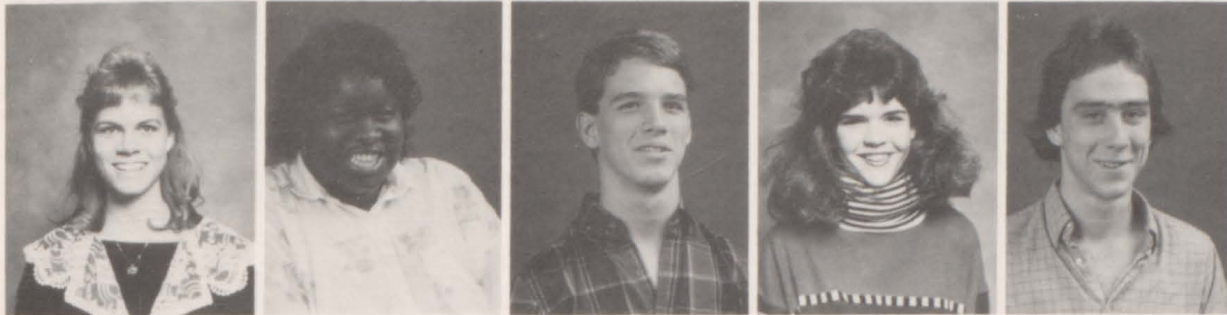

Elizabeth Coleman  
Alonda Cox  
Jody Criswell  
Stephanie Crocker  
Bill Cross



James Dabbs  
Tracy Davis  
Tripp Davis  
Walter Dickson  
Belinda Dunn



Jeremy Dunn  
Julia Edwards  
Steven Edwards  
Terrence Elder  
Lisa Elliott

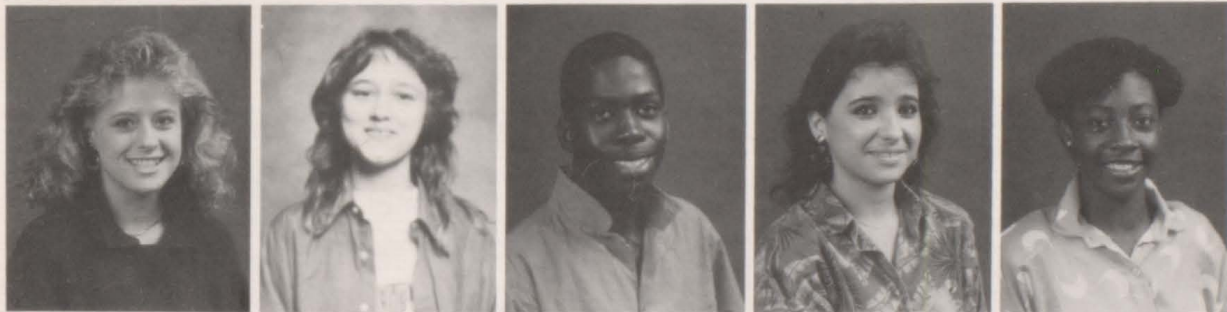

Sheila Elliott  
Becky Fant  
Tim Farmer  
Brandi Fowler  
Melissa Gentry



Paul Glass  
Amy Gordon  
Rosie Graves  
Patti Gray  
Doug Hall

Joseph Hammonds  
 Carla Hayes  
 Chris Hill  
 Crystal Hudson  
 Santana Hunt



Rick Ingram  
 Cynthia Johnson  
 Nicola Jones  
 Brad Joyce  
 Will Kinton



Ed Landers  
 Anthony Lawrence  
 Denise Lawrence  
 Kevin Lewis  
 Michael Lipinski



Sandra Little  
 Carla Litton  
 Bobby Lollar  
 Robbie Lott  
 Anthony Love



Leonora Lowery  
 Eugenia Lutten  
 Robert Lutten  
 Stephanie Maitland  
 Cedric Mayberry

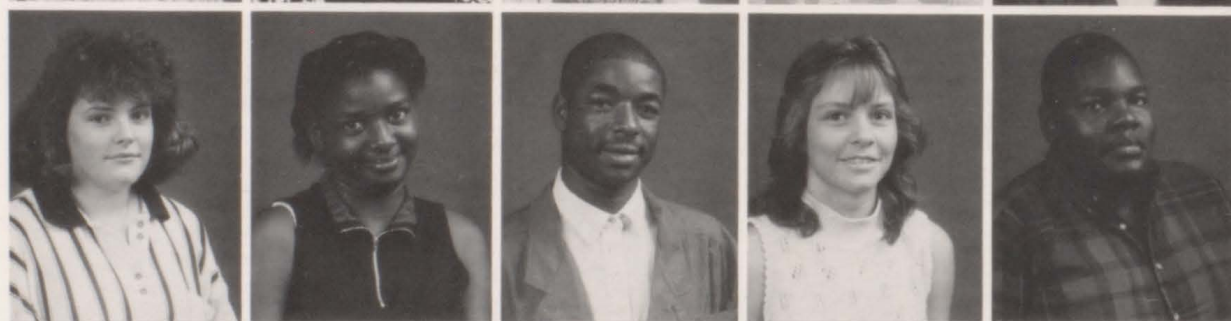

Crysti McCaslin  
 Melissa McFadden  
 Eric Milan  
 Keisha Milan  
 Jimmy Mitchell

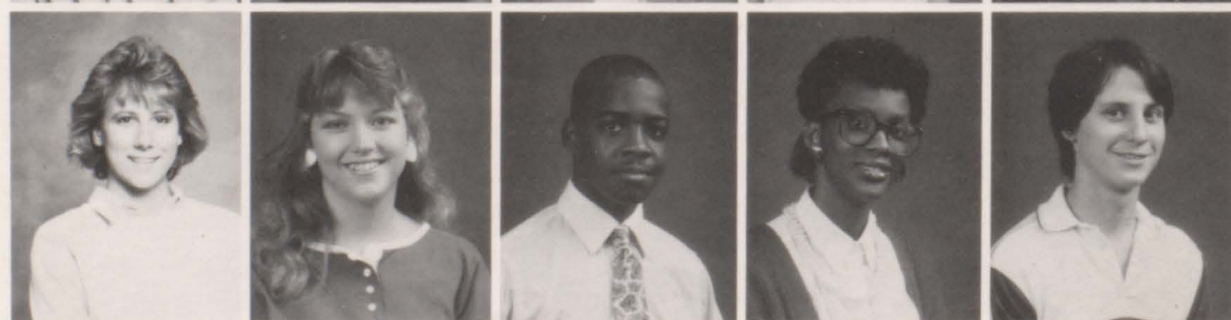





Shawn Mosley  
Gene Noble  
Andy Northrop  
Candy Parrish  
Anne Peebles



Charlie Penn  
Dana Peterson  
Brian Pipkin  
Stacey Pope  
Carolyn Pruett



Holly Richardson  
Aretha Rinkines  
Trevor Rinkines  
Mike Roberts  
Melissa Rutledge



Sheila Saxsma  
Brent Scott  
Kim Sharp  
Michelle Sharp  
Brad Simmons



Andy Smith  
Amy Stewart  
Tim Tatum  
Andy Thompson  
Cynthia Tipton



Greg Tubbs  
Stephanie Turner  
Deanna Tyner  
Jamie Usery  
Neva Vasser

Carlesia Vaughn  
 Renetta Wade  
 Tonya Walker  
 Beth Walters  
 Angel Warren



Angela Watson  
 Bryan Watson  
 Chas Weems  
 Melinda Welch  
 J.J. Whitwell

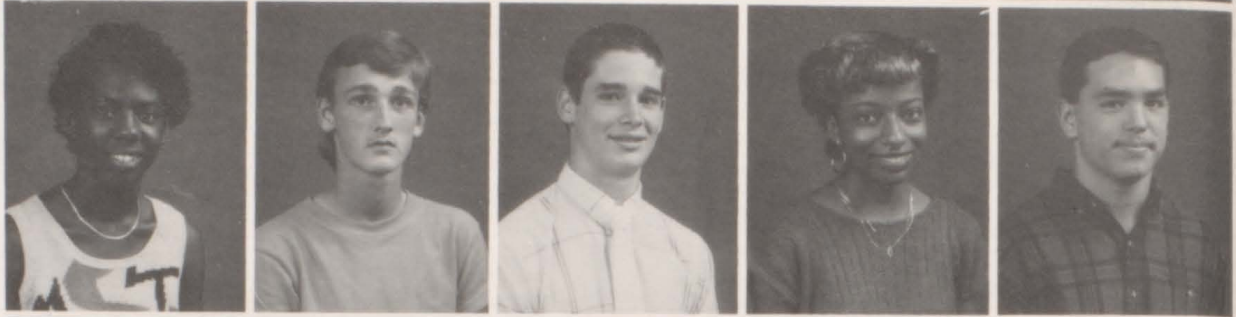

Kristie Williams  
 Steve Williams  
 Melinda Wilson  
 Matt Wright



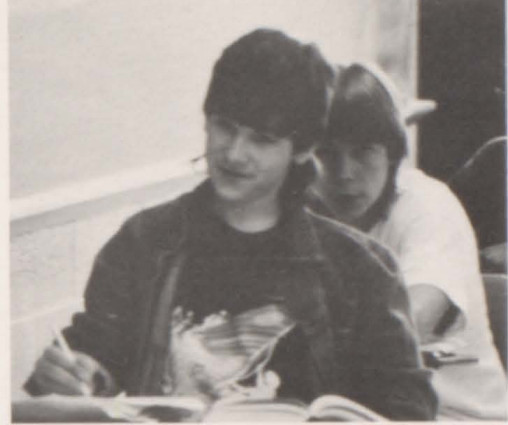



SPECIAL MEMORIES

ONCE WE WERE JUNIORS

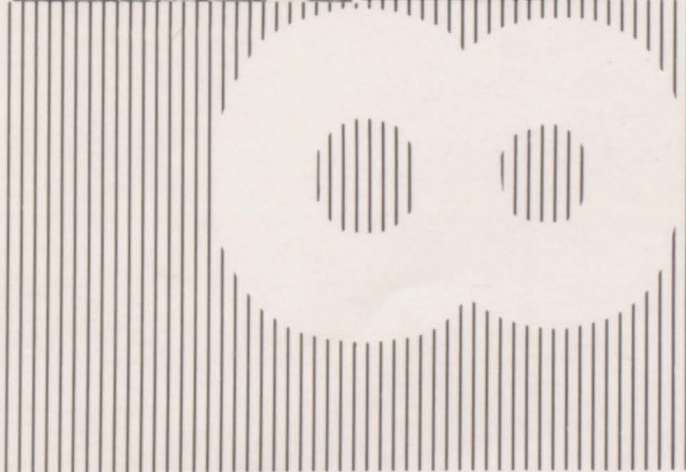

# JUNIOR CLASS

The Class of '89 is hard to describe; being a large class there is much diversity. We have academics, we have athletes, we have band members, we have leaders, and after years of school together a circle of friendship has formed, uniting us into one large family.

So when the quarterback's football is replaced with a briefcase and the cheerleader's skirt is exchanged for a nursing uniform, an era will have passed, but memories of the years at P.H.S. will live on — forever.

CLASS OFFICERS: Jason Cox, president; Tia Smith, vice-president; Maria Doaks, secretary; Stefan Gore, treasurer.



Jerry Albea  
Linda Anderson  
Randy Anderson  
Cory Arnold  
Rickey Barton

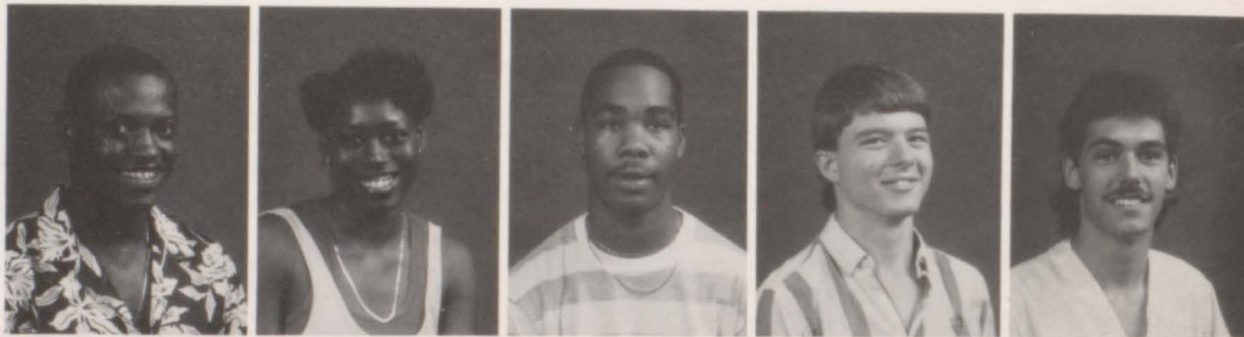

Stacey Barton  
Elizabeth Bridges  
Toni Brown  
Robert Buchanan  
Terry Campbell



Laurie Carter  
Charles Cliff  
Mark Cliff  
Chris Coffman  
Beth Cooper

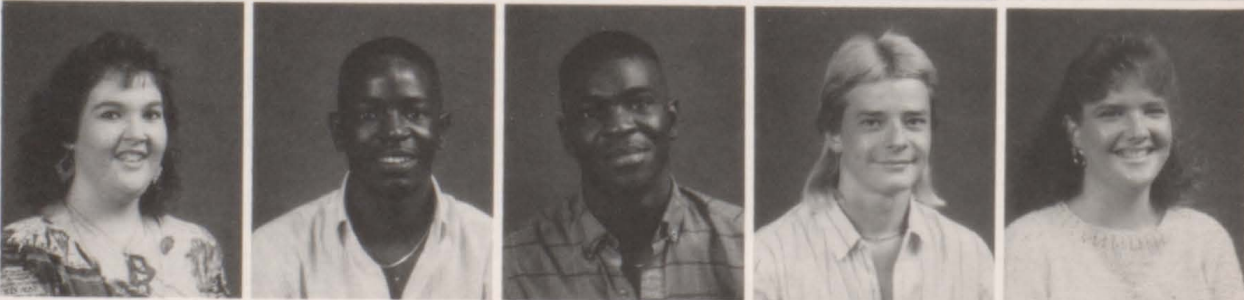

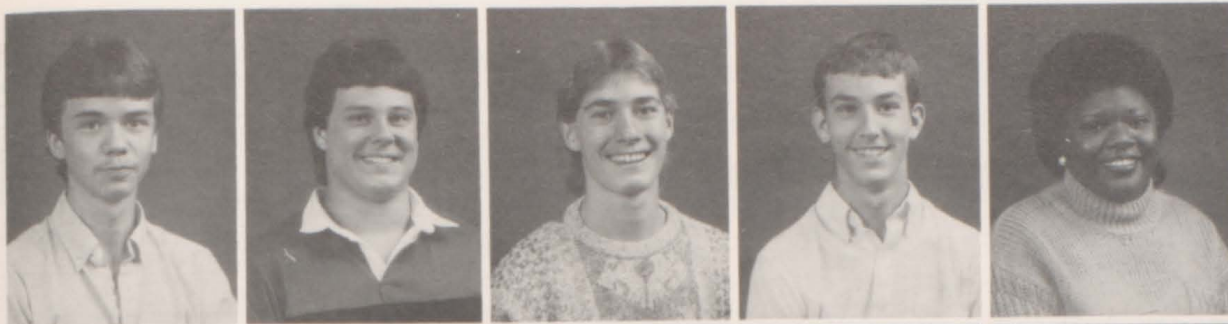

Brad Copley  
Jason Cox  
Brett Crider  
Stan Davidson  
Maria Doaks



Tina Downs  
Shawn Easley  
Lisa Edmonds  
Beth Edwards  
Lee Espey

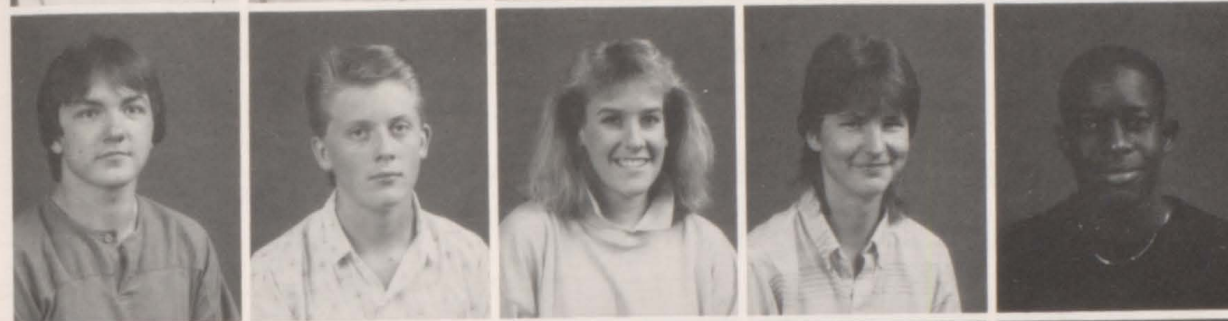

Robert Fant  
Doug Ferguson  
Amanda Fortner  
Mike Gant  
Melvin Gentry



Ronald Gentry  
Tracy Gibson  
Aimee Glisson  
Sharon Gonzalez  
Tyrone Gooch



Stefan Gore  
Mike Gradisher  
Annette Graves  
Kathy Graves  
Michelle Graves



Richie Hampton  
Bridget Harper  
Kim Harrell  
Johnny Harrison  
Robert Hartfield

Shannon Hawkins  
 Charlie Hensley  
 Danny Hensley  
 Mike Hensley  
 Kim Hill



Penny Hill  
 Anthony Hilliard  
 Amanda Hinson  
 Jeremy Howell  
 Paul Hudson



Danny Humphreys  
 Gerald Hunt  
 Tammy Hunt  
 Terry Hurt  
 Barbara Johnson



James Johnson  
 Kim Johnson  
 Wesley Johnson  
 Doug Jones  
 Jennifer Jones

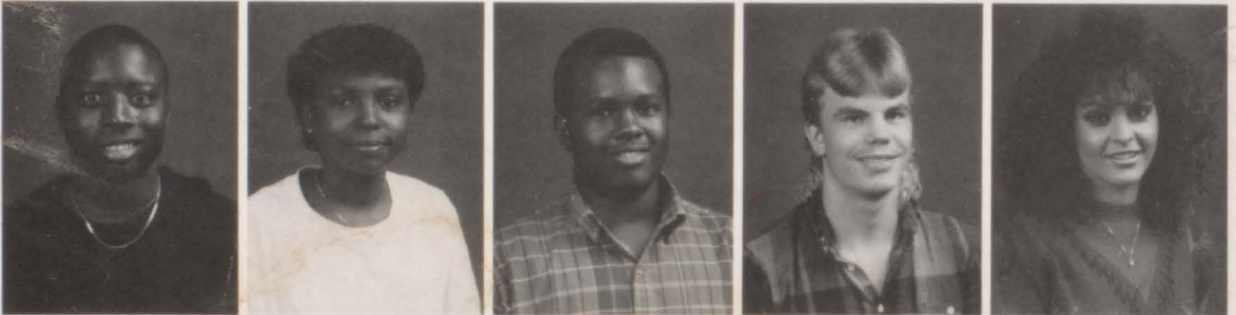

Keisha Jones  
 Jayme Juhl  
 Jim Juhl  
 Mark King  
 Corey Kinton



Jeremy Kiser  
 Shane Koffman  
 Carla Lancaster  
 Kim Lawhorn  
 Arron Lee





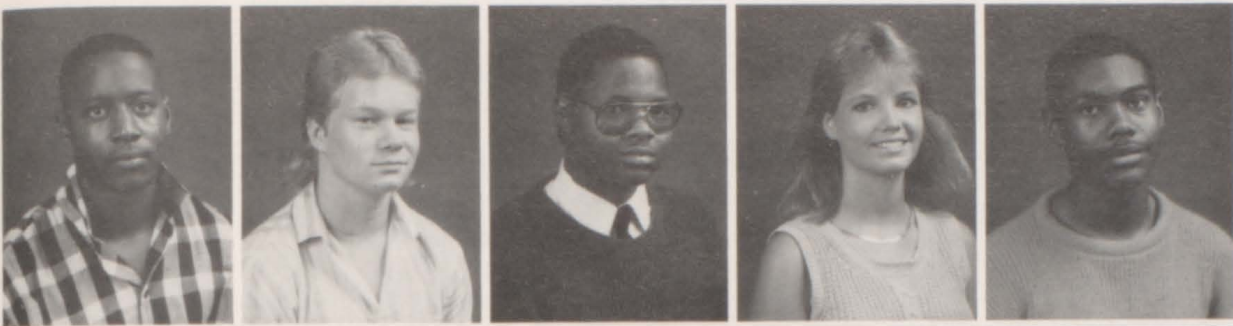

Len Lewis  
William Lowery  
Stephen Mack  
Sheila Maness  
Kenny Marsh



Malcolm Marsh  
Louis McDaniel  
Gina McVay  
Portia Milan  
Amy Milligan

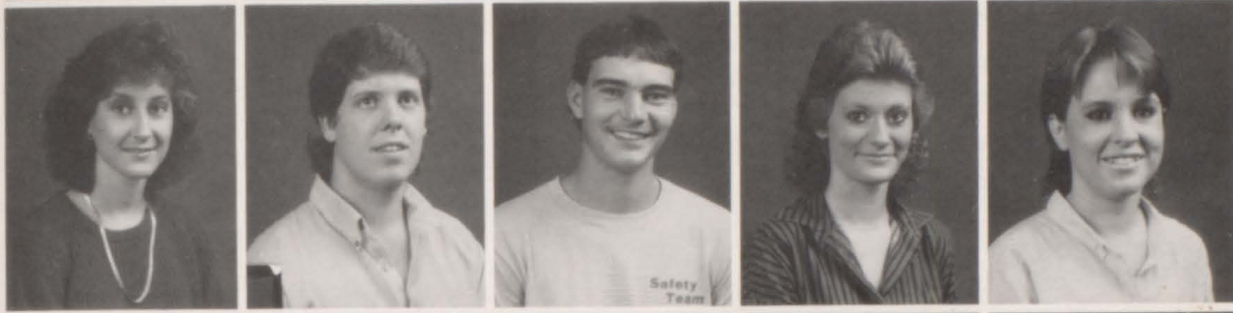

Camille Moore  
Daniel Moore  
Roger Morgan  
Tiwana Mosier  
Jewel Partin

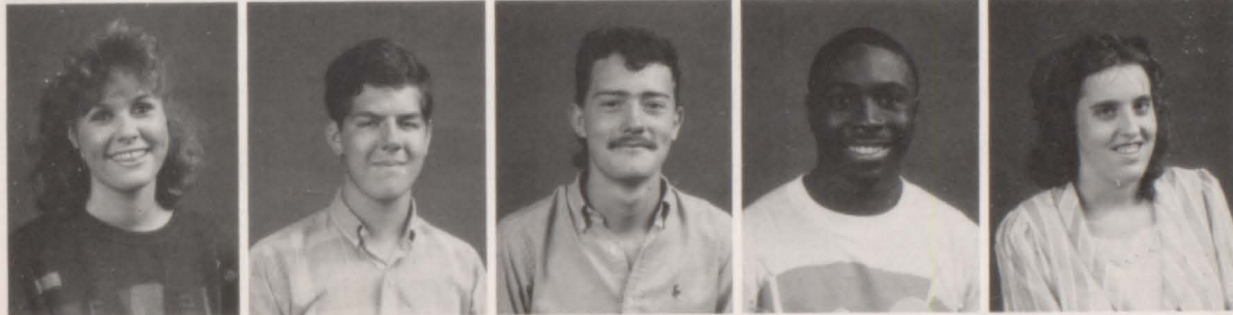

Jessica Phillips  
Michael Poteet  
James Powell  
Ross Price  
Patricia Qualls

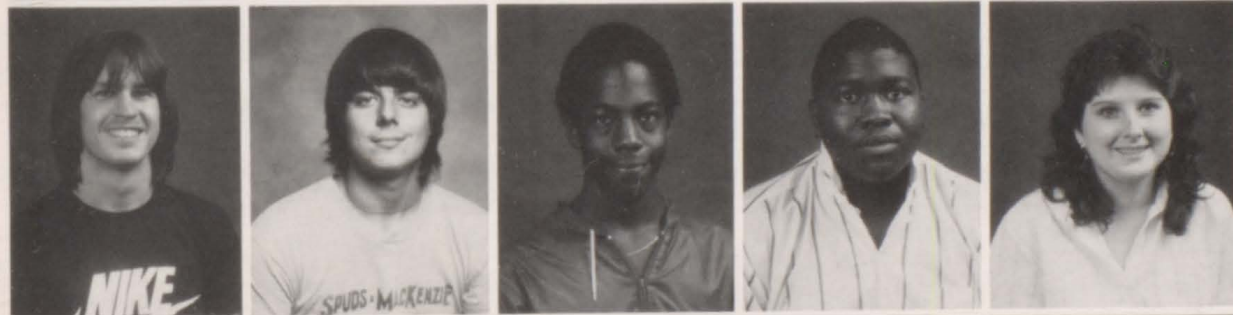

Brad Rainwater  
Jimmy Riggs  
Roger Rinkines  
Louis Robinson  
Michelle Rutledge



Michael Sanders  
Phil Sanderson  
Keith Sanford  
Sherry Saxsma  
Melanie Scott

Larry Setzer  
 Berry Sharp  
 Mark Shearon  
 Robby Shelton  
 Samantha Slaughter

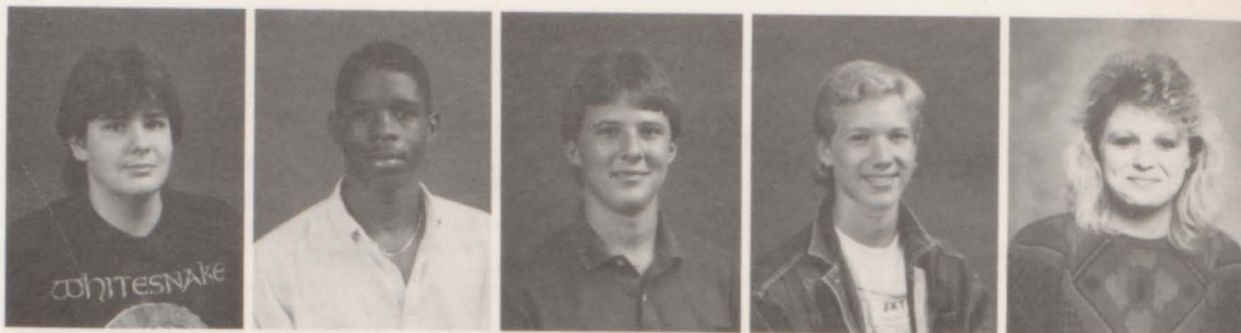

Stephanie Smith  
 Tia Smith  
 Bobby Stewart  
 Beverly Stoots  
 Kevin Summars

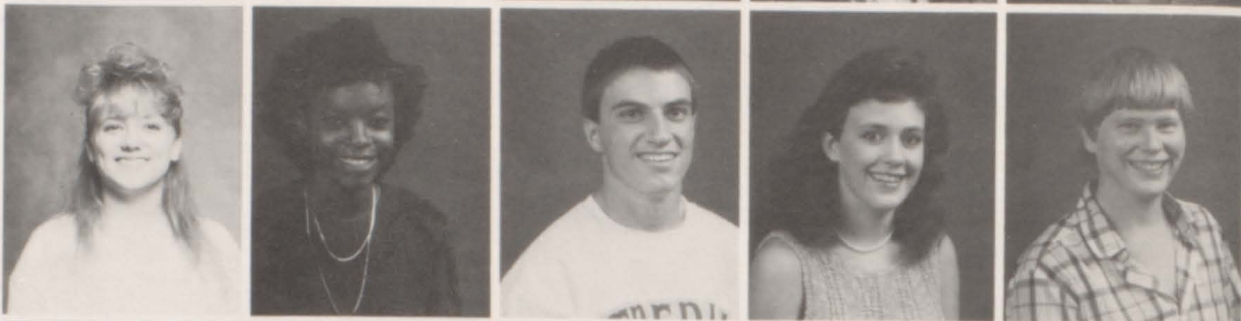

Anthony Talley  
 Paul Talley  
 LeeAnn Taylor  
 Rene Thomas  
 Dawn Thompson



Penny Thompson  
 Tim Tole  
 Amy Turner  
 Brenda Usery  
 Calvert Vaughn



James Virginia  
 Marvin Wade  
 Lynn Walker  
 Link Ward  
 Lisa Warren



Katrena Watkins  
 Bobby White  
 Jamie White  
 LeighAnne  
 Whitehead  
 Alicia Williams

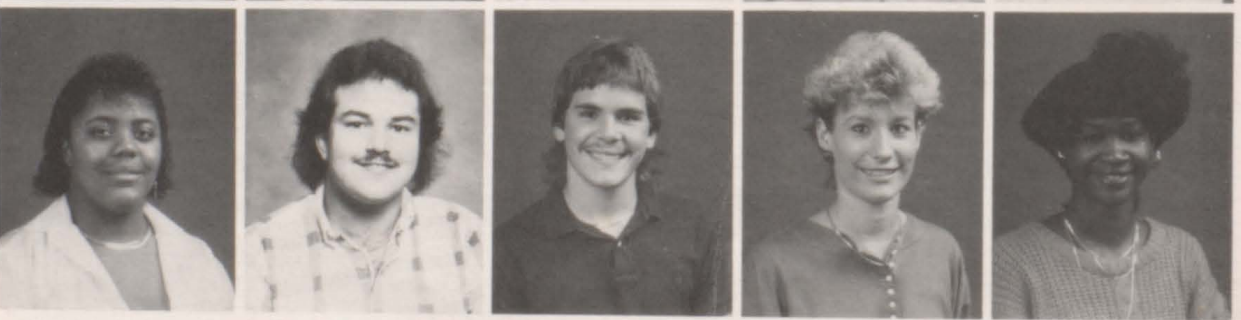

Charlie Williams  
 Velma Williams  
 Kim Yarbrough  
 Timmy Young  
 Jeff Ziegenhorn

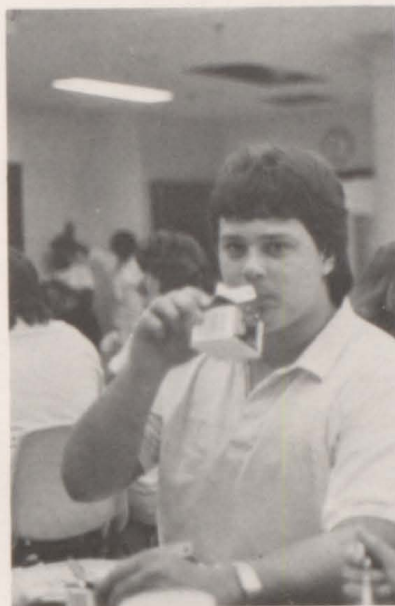
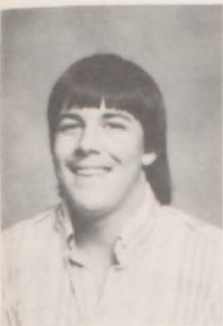

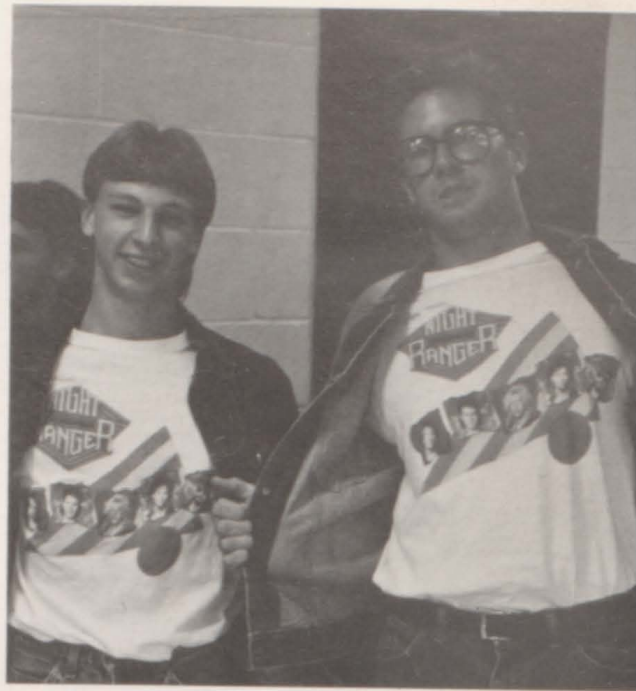

ONCE WE WERE SENIORS

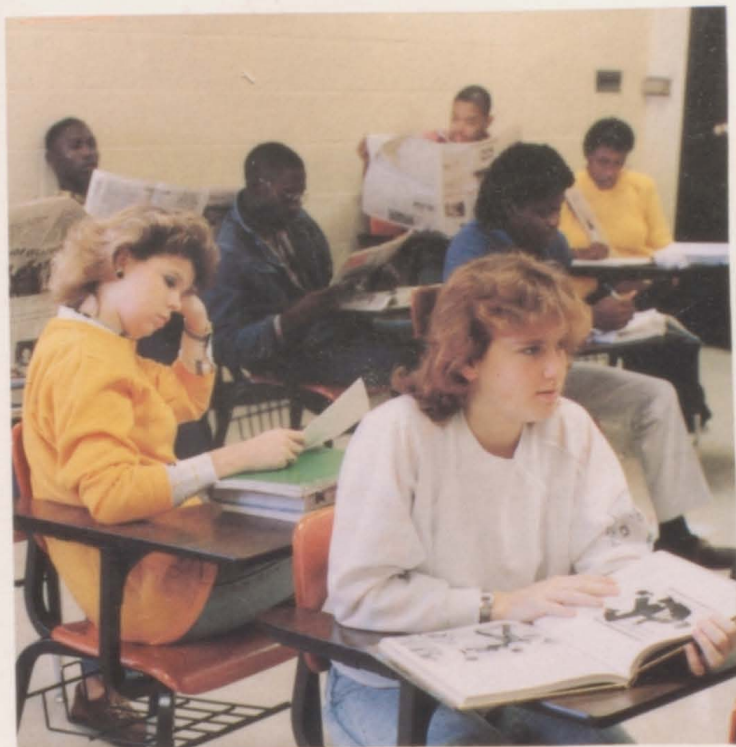

19

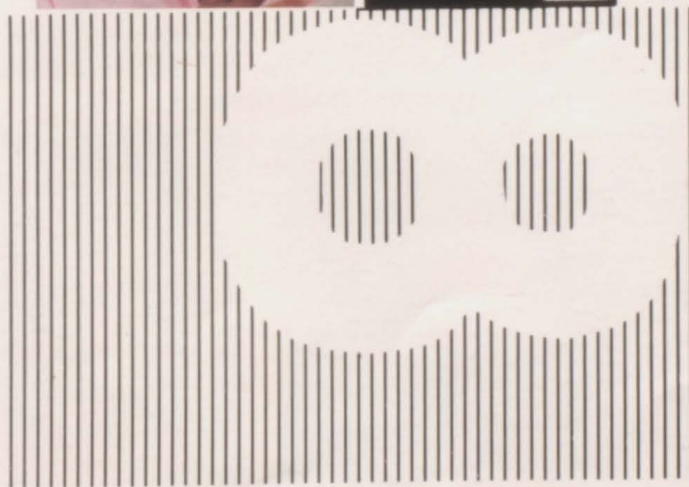

# 1988 SENIOR CLASS OFFICERS



Crystal Coleman, secretary; Steve Prince, vice-president; John Prince, president; Susan Sisk, treasurer.

One cannot summarize four years of high school in a few short paragraphs. The times of fun and laughter have been too many to remember, and they have brought us all together. As we wended from freshmen to seniors, we encountered many trials and tough times, but we got through them together. We learned that we all had different talents and gifts given to us, and we used them to produce a class full of spirit and versatility.

Over the years, the class of 1988 has proven its credibility many times. We have proven that we

can take on any challenge and succeed. Though we may part and go different ways in the future, we will look back upon our high school years for comfort and guidance. We will remember the good times and learn from the bad.

Our job is done here. Our mark has been made. Peabody will be a better place because of us, and we will be better people because of our experiences here.

— John Prince

# SENIORS

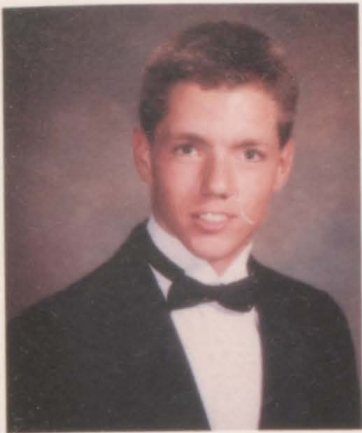

Gregory William Abbott

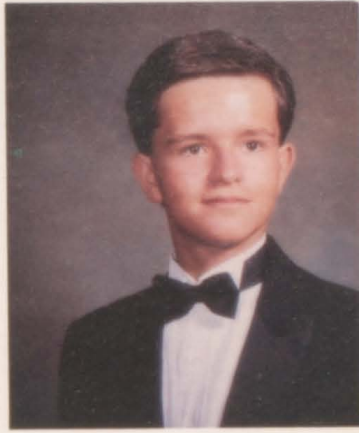

Frank Nathan Anthony

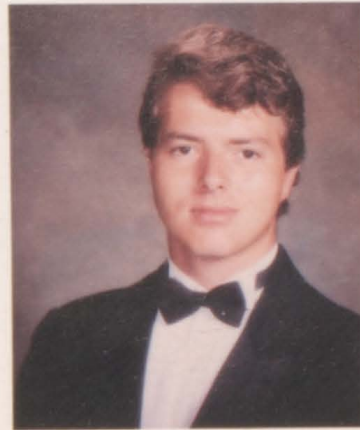

Jay J. Arnold



Rhonda Dawn Ashley



Sonya Dale Bailey



Carla Rochelle Barnes



Angelia Leonora Barnett



Clay Allen Barrix

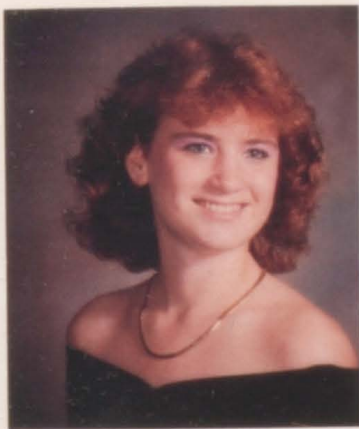

Kathleen Ann Becker



Susan Darlene Bell



Jeffrey D. Blankenship



Mitzie Renee Branch



Elizabeth Jane Brown



Lisa Carole Brown

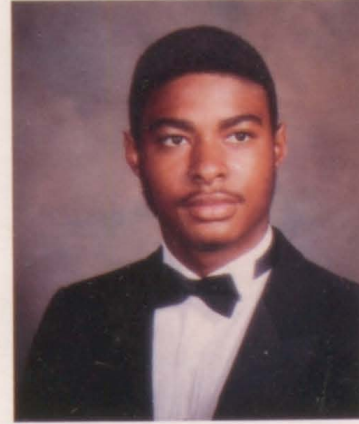

William Harold Brown



Douglas Keith Buchanan

# SENIORS

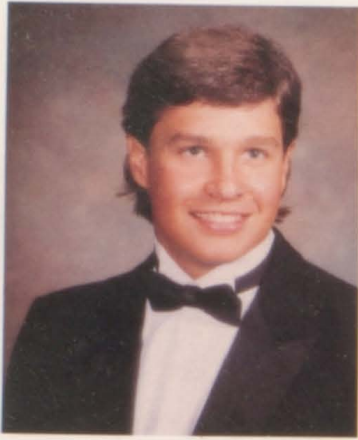

Brent Howard Bunch



Kevin Lee Burress



James F. Campbell



Mary Anne Canada

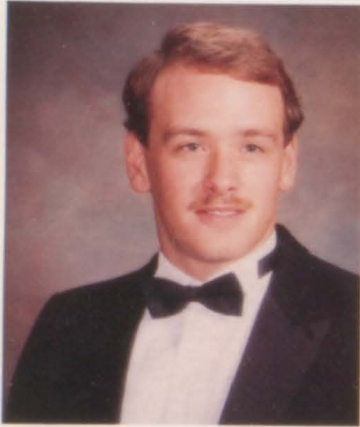

Gregory Paul Cannon



Alexander L. Clark



Tricia Dee Clark

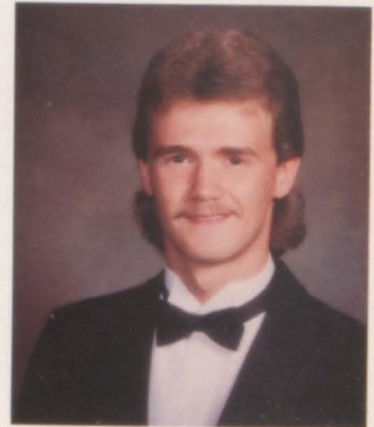

Timonhy David Cloyd



Susanne Denise Coffman



Crystal Sue Coleman



Teresa Lynn Cox



Paul Jeremy Cromley

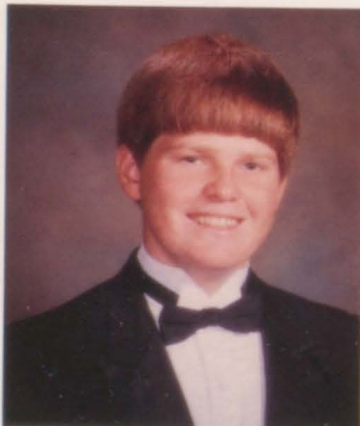

Bruce Edwin Davis

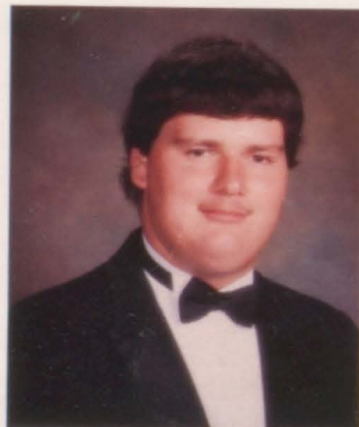

Timonhy Leon Davis



Susan Renee Dorsett



Angela Dowdy



# SENIORS

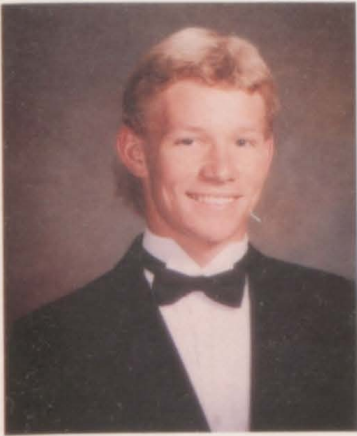

Robert C. Dublin

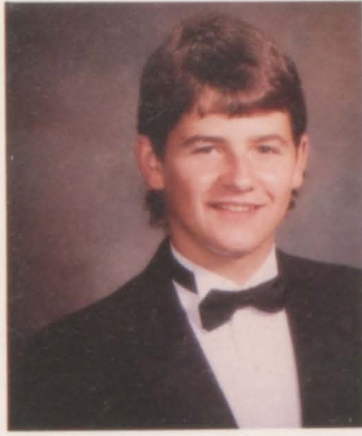

Michael Anthony Dubrule

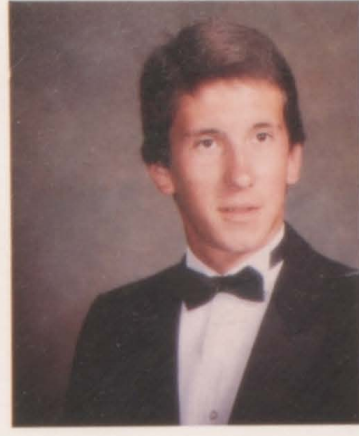

Joseph Allan Dudley



Erika Deniece Edwards

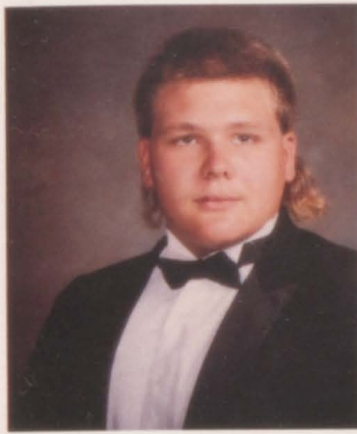

Herman Scott Edwards

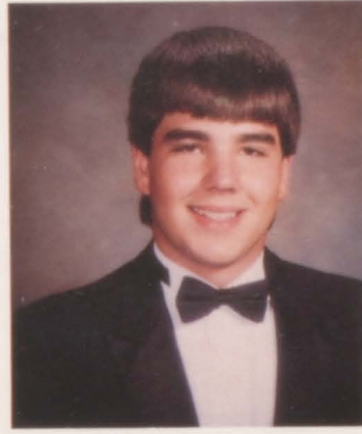

Charles McCain Elgin



Robbie A. Elliott



Brian Keith Fetters

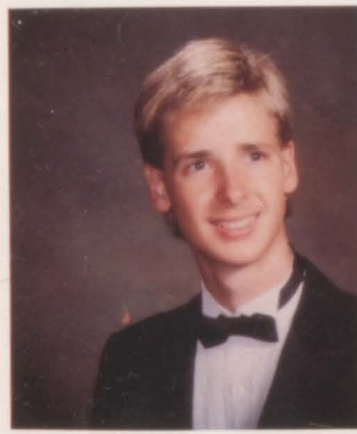

William R. Fron

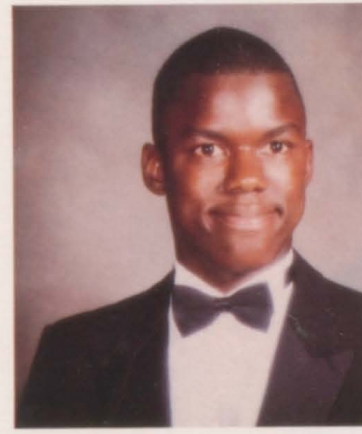

Thetford Douglas Ganaway

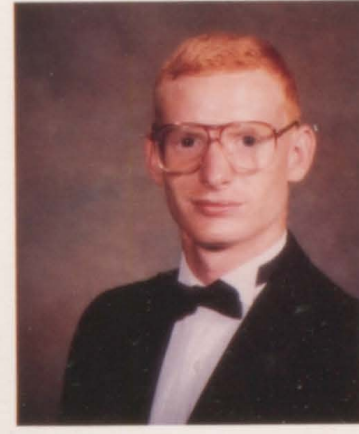

Warren L. Gannon



Ruth Ann Gipe



Holly Kay Glidewell



Stephanie Goodwin



Christina Marie Graves

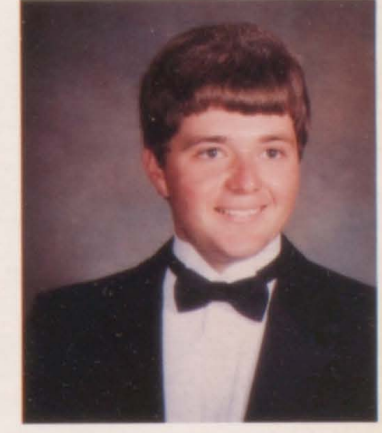

James Edward Graves

# SENIORS

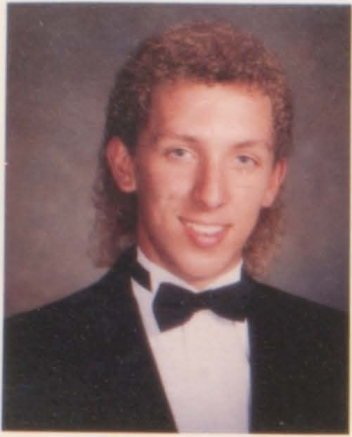

James Christopher Greene



Karen Marie Griffin

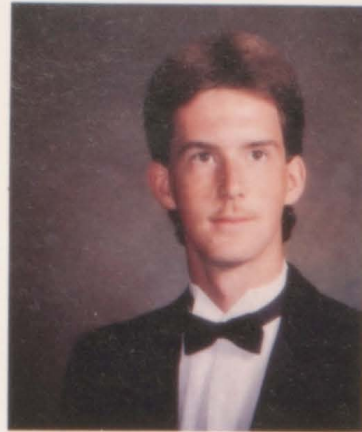

Jeffrey Dean Hankins

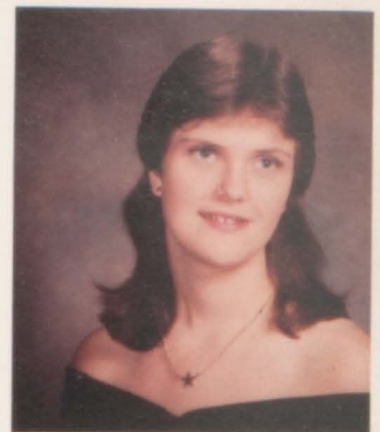

Jennifer Lynn Harper



Missy Harper

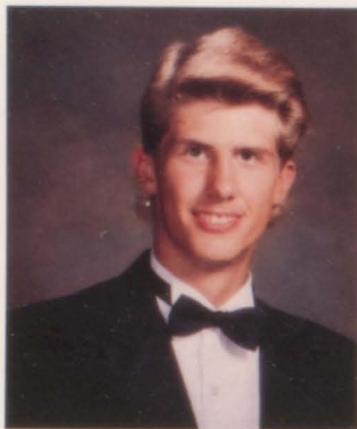

Todd Edward Hensley

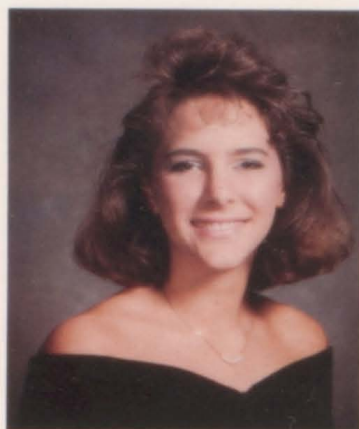

Michelle Dawn Hickerson



Paula Ann Hickerson

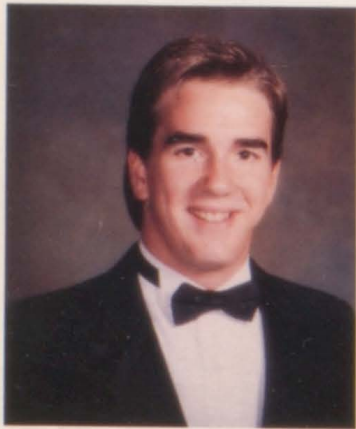

William Karsner Hodges

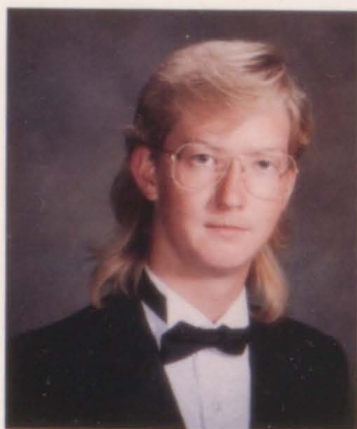

Robert H. Holmes III



Wendy Gail Hooper



Vickie Lejean Jarrett



Laquissa Rashelle Johnson



Trina K. Johnson



Jeannie Cheryl Kent



Brent Dale Kimery

# SENIORS

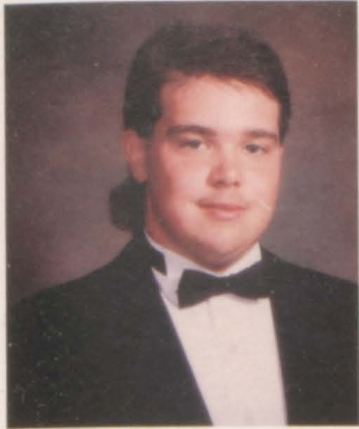

Michael Lee Langston



Angela Faye Lewis



Melinda Cherie Little



Melissa Cheryl Little



Colis Osler Long



Sabrina Renee Mackin



Pamela Mance

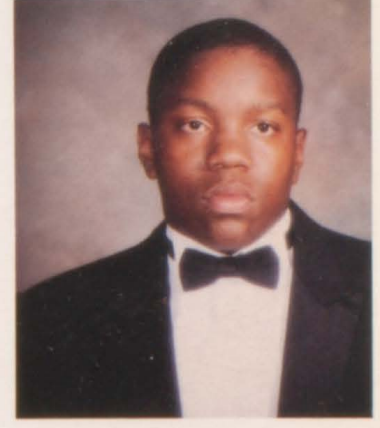

Oliver Cornelius Mayberry

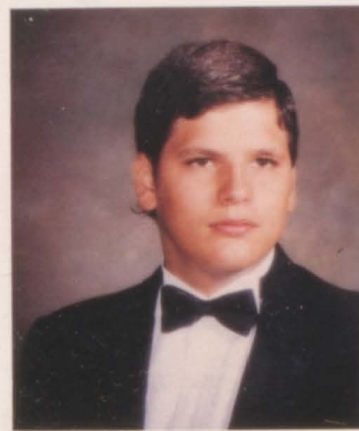

Craig E. McAlexander



Stacy Lynn Miller

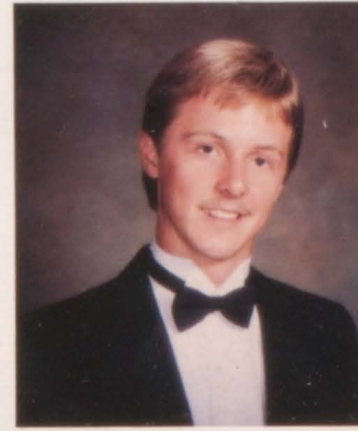

Kevin E. Milligan



Sherri LaRae Milligan



Anthony R. Moore



Rodney Lewis Nance

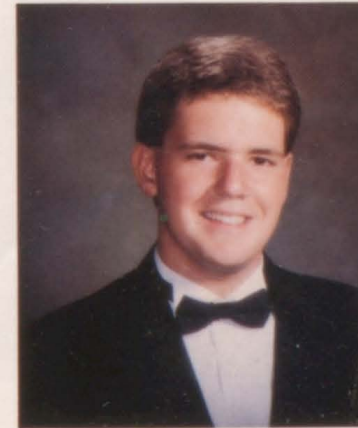

Gavin Len Orgain



Lora Kay Parnell

# We the People





P.H.S. CLASS OF 1988

# SENIORS



Lisa Renee Partin

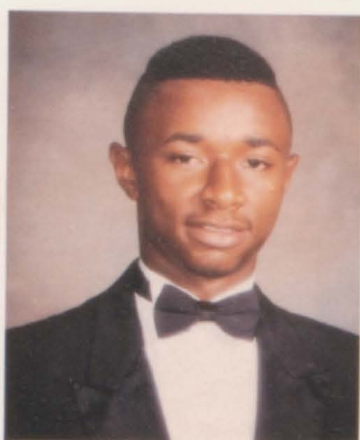

Eldred CaVaughn Peterson

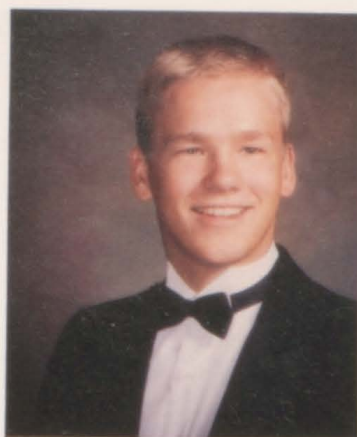

John R. Prince

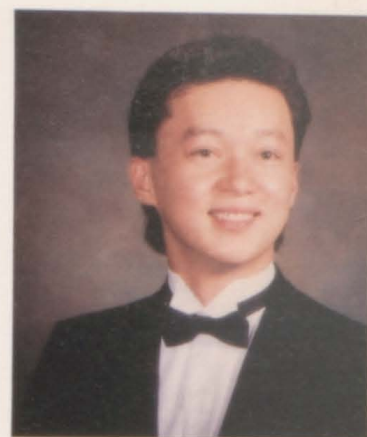

Steve Yi Prince



Lisa Carmen Rangel



Melissa Annette Rawdon



Daphyne Rumay Ray

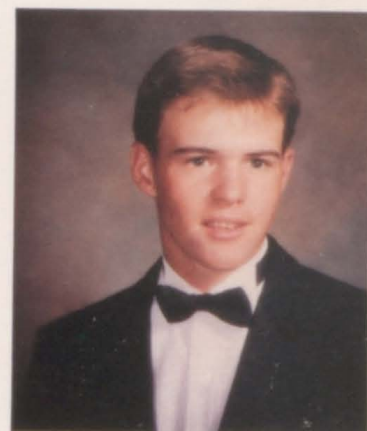

Forrest Dale Reasons

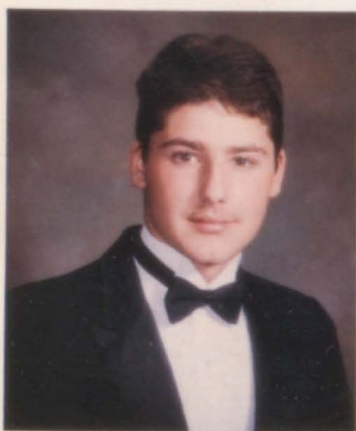

John Jay Richardson



Gregory Wayne Rinks

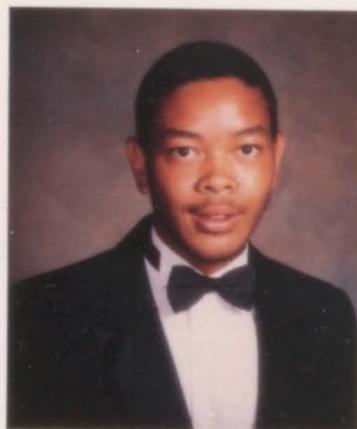

George Robinson



Mary Bernnadette Robinson



Amanda Jane Russell



Miyoshi Levette Russell

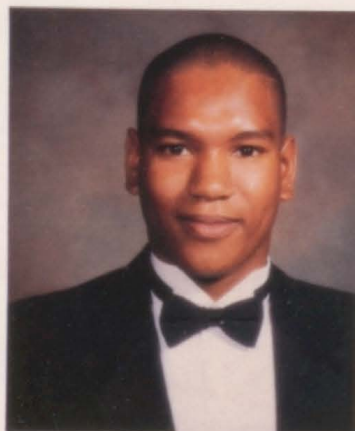

Rodney Karenski Russell



Jason Christopher Scott

# SENIORS

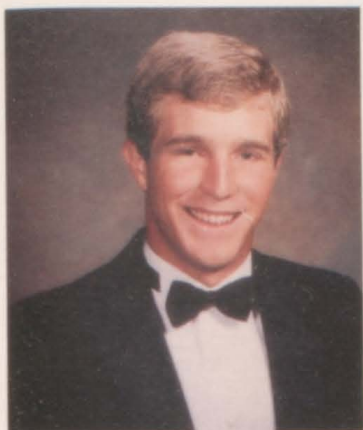

Bradley E. Scruggs

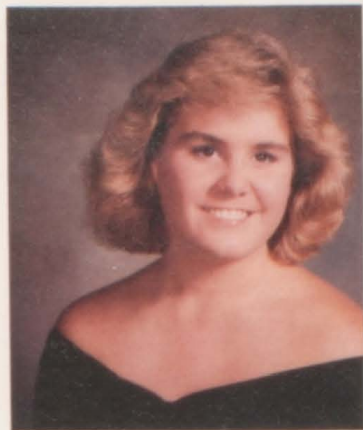

Crystal Renee Shepherd



Susan Jane Sisk

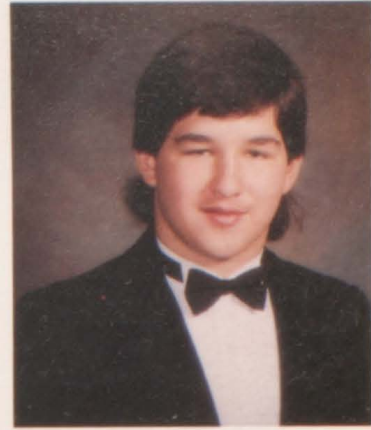

Joel Timonthy Smith

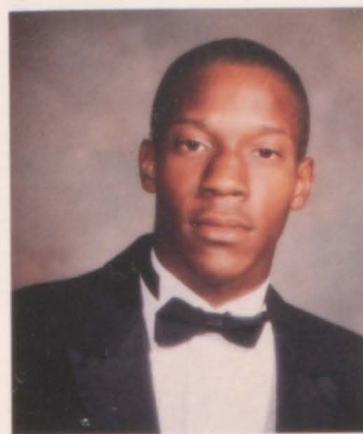

Gary Lynn Swift



Joseph Talley



Christopher Dwayne Temple

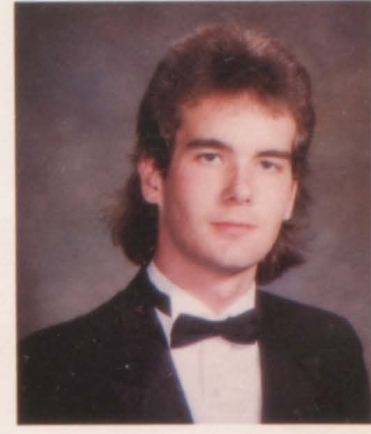

Thomas W. Thedford



Denise Thetford



Rebecca Mechell Thomas

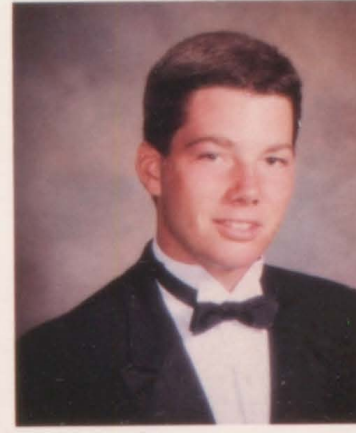

James C. Thompson



Margaret Denise Thompson



Patricia Rae Trull



Amy Regina Turner



Melissa Naomi Turner



Sherry Lynn Tyner

# SENIORS



Sheila Marie Virginia

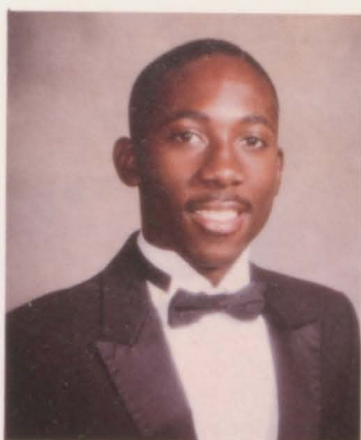

Courtney B. Wade



Kimberly Ann Wade



Linda F. Wade

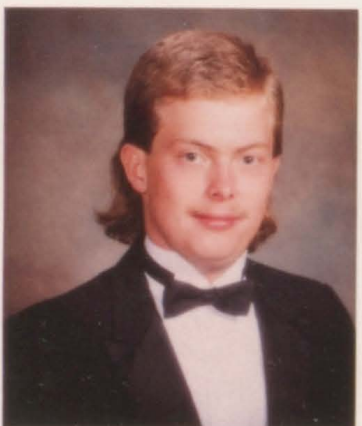

Michael L. Wallsmith



Cecelia Rachelle Ward



Wendy R. Warren



Veronica R. Dodd Welch



Alice Sue Williams



Carol F. Wilson

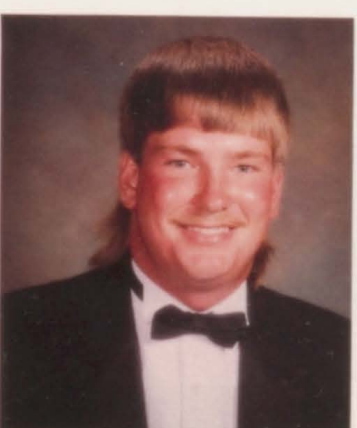

Micah Cory Wilson



Melissa Dawn Wilson



Janet Marie Wood



Edward Charlton Zarecor





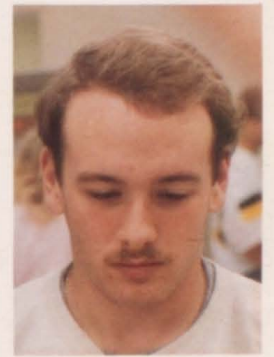
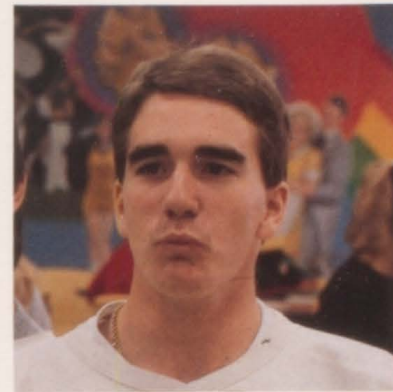
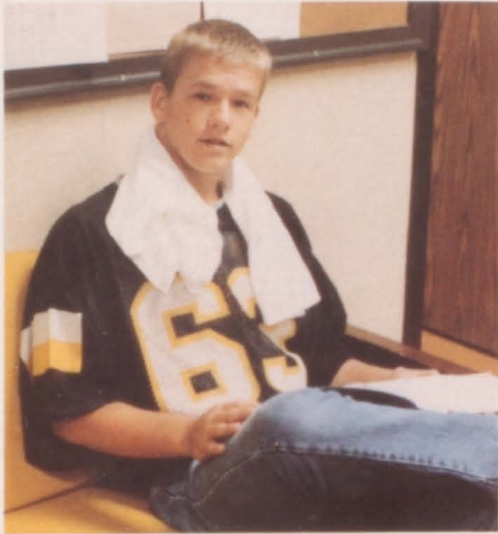
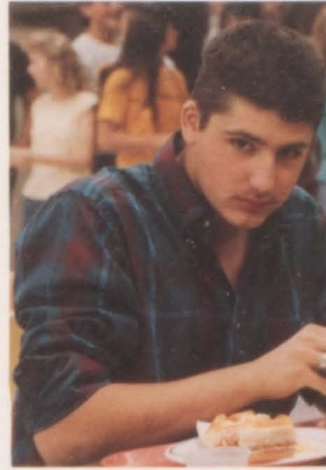
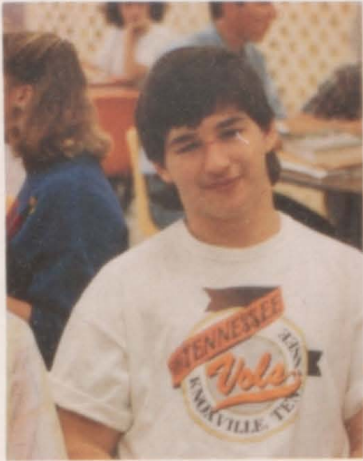

Once upon a time ...





Think for just a moment,  
Where we've gone and been.  
It seemed our time together would never end.

Time has gone by so very fast.  
We'll always remember the good times  
And a lifetime of memories that will last.

Now we're all wondering where each of us will  
go.  
The days are drawing nearer;  
It's time to set our goals.

We've learned, laughed, and cried together  
And now we'll be separated —  
Individuals on our own.

But our class is very special in its unique way.  
We'll always be together in spirit  
No matter how far we are away.

To the Class of Nineteen hundred and Eighty-  
eight,  
If we all believe in each other we can,  
So as we look into what has been  
We know that we'll part as everlasting friends.

— Denise Thompson

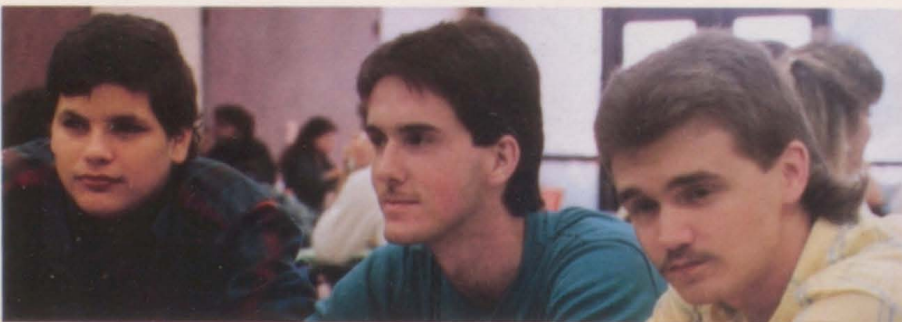
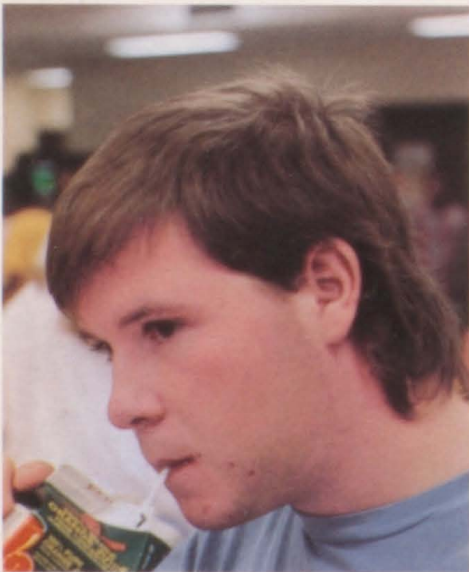
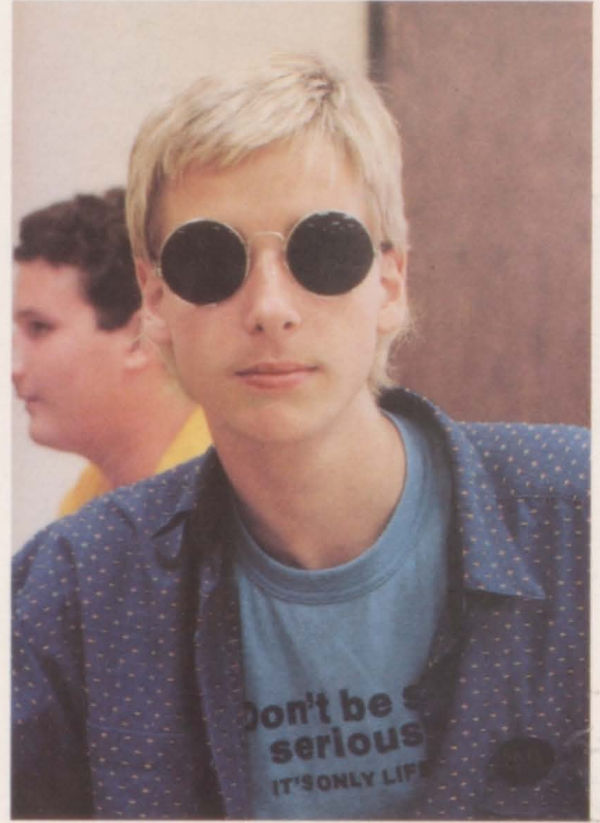
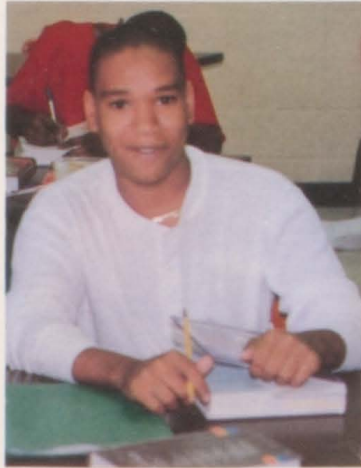
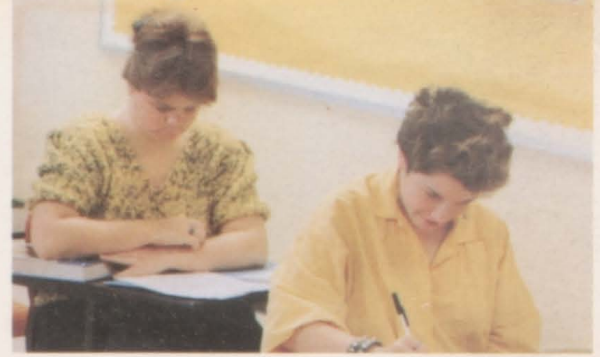

# SENIOR HONORS



John Prince — Susan Sisk

# OUTSTANDING SENIORS

Dependability, leadership, academic endeavor, attitude, and participation in school activities are the criteria for being selected as an Outstanding Senior. To be recognized as an Outstanding Senior is one of the most prestigious recognitions given at Peabody. The faculty selects these students for their performance over four years. Students are nominated for this award and then rated on each criterion. Students with the highest average scores are given recognition.



FRANK ANTHONY



SUSAN BELL



JEFF BLANKENSHIP



MITZIE BRANCH



BRENT BUNCH



GREG CANNON



ROB DUBLIN



STEPHANIE GOODWIN



LAQUISSA JOHNSON



Lora Parnell



John Prince



Steve Prince

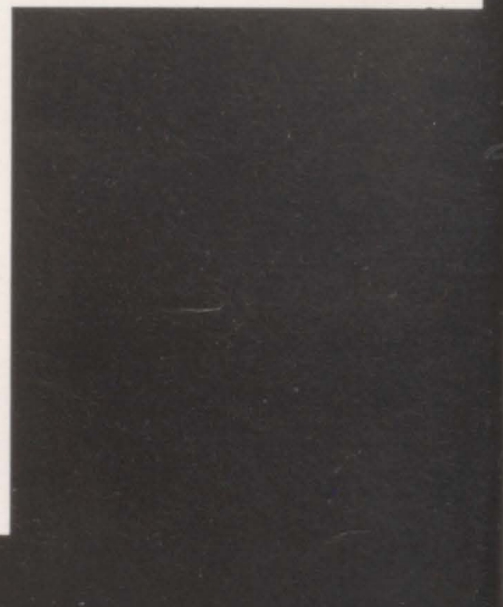

Susan Sisk

Thirteen students from a class of 126 were selected as Outstanding Seniors. Being chosen for the honor gave them pleasure and a feeling of accomplishment. They, as Outstanding Seniors, appreciate the teachers for their support and recognition of their work through their years at Peabody.



VALEDICTORIAN

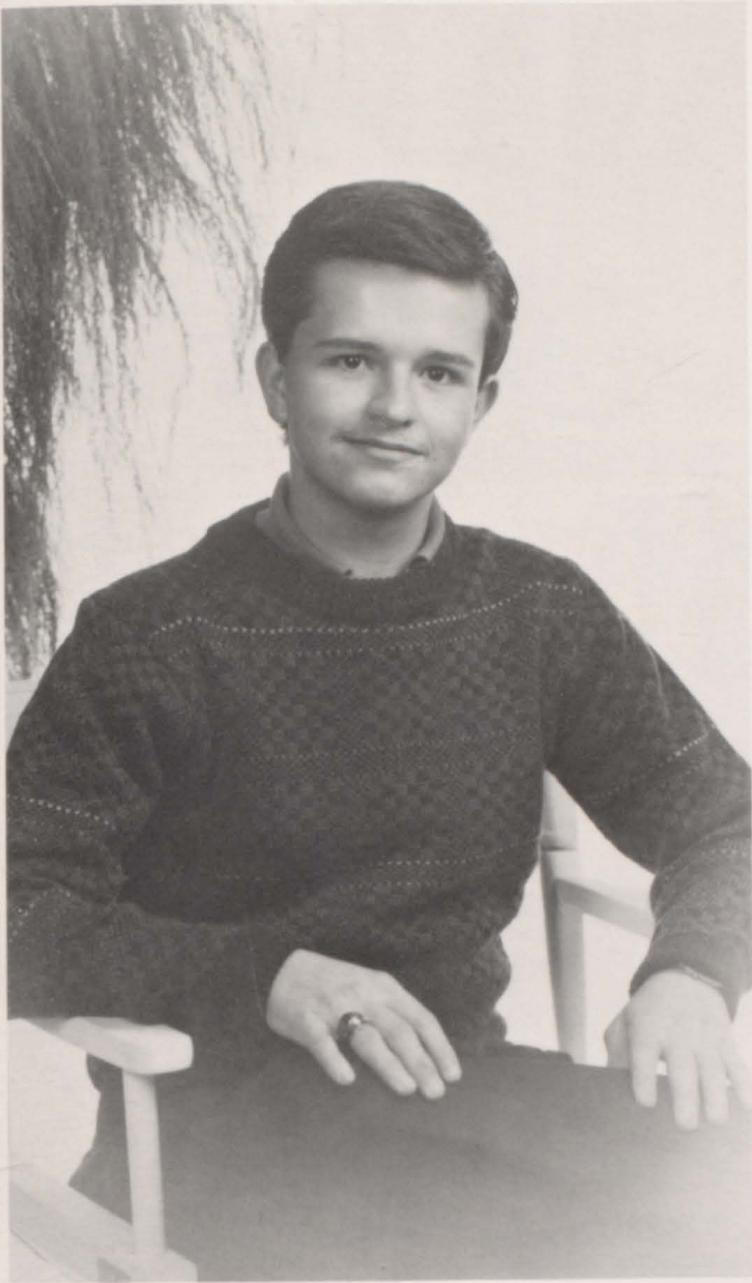

Frank Anthony — 97.97

SALUTATORIAN



Jeff Blankenship — 97.71



## TOP TEN PERCENT

1 Lora Parnell	97.65
2 Gavin Orgain	97.26
3 John Prince	97.21
4 Brent Bunch	96.72
5 Stephanie Goodwin	96.00
6 Susan Sisk	95.67
7 Todd Hensley	95.66
8 Eddie Graves	95.51
9 Mary Canada	94.98
10 Patti Trull	94.90
11 Erika Edwards	94.85



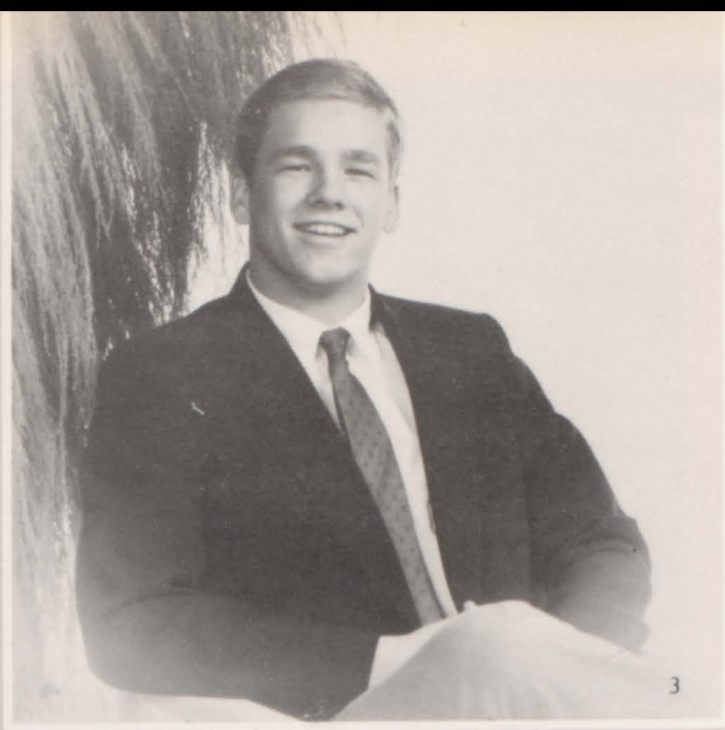

# SENIOR SUPERLATIVES

## MOST LIKELY TO SUCCEED

Frank Anthony — Lora Parnell



By reviewing the characteristics of the Senior Class, Senior Superlatives categories are selected by the annual staff each year. Members of the class are elected and given recognition for the category they fit best.



## MOST DEPENDABLE

Jeff Blankenship — Tricia Clark



## WITTIEST

Mike Dubrule — Angela Lewis



## MOST ORIGINAL

Chuck Thompson — Mitzie Branch



## MOST ENTHUSIASTIC

Steve Prince — Miyoshi Russell

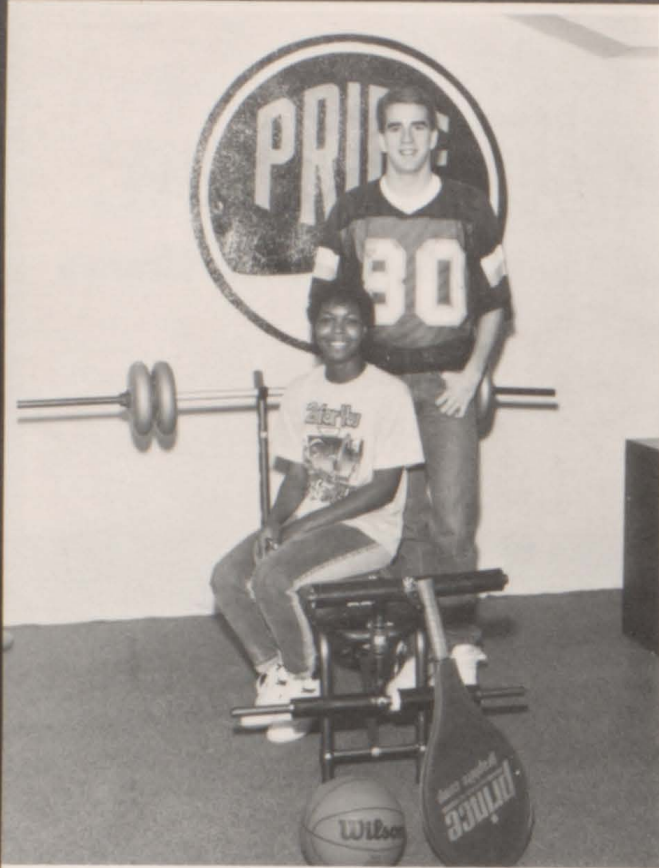

## MOST ATHLETIC

Bill Hodges — Veronica Welch



## MOST TALENTED

Jason Scott — Elizabeth Brown



## AMERICAN LEGION AND D.A.R. CITIZENSHIP AWARDS

Bill Hodges — Elizabeth Brown

# ORGANIZATIONS



*Lets Keep Pride  
in the  
Tide"*



19

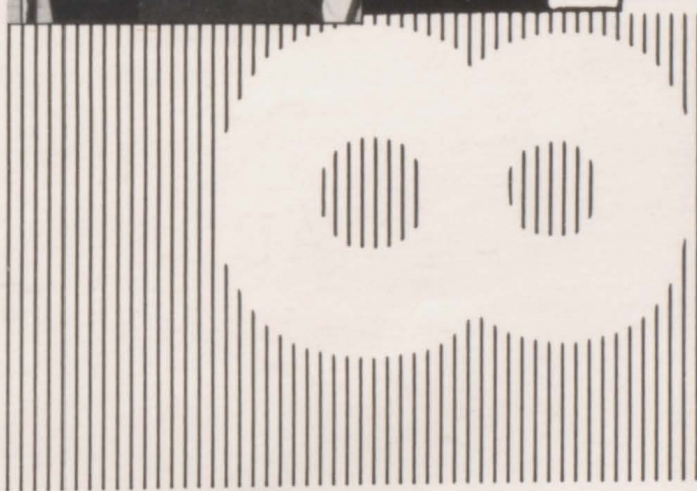

# GOLDEN TORCH '88



When we set out to publish the 1988 Golden Torch we never dreamed of all the hardwork and dedication it would take. We were an unexperienced staff with different thoughts and ideas. Although we were a diverse group, we have become closer and learned a lot about each other in the process.

We hope that we have captured all of the memorable moments of the 1987-1988 school year. We did not make this book for us; we did it for the student body of Peabody High School. We hope you will appreciate these moments in the years to come.



1 Stephanie Goodwin, Editor  
Denise Thompson, Copy Editor

2 Mitzie Branch, Layout Editor  
Jason Scott, Art & Layouts

3 Ruth Ann Gipe, Photography & Layouts  
Doug Ferguson, Photography & Layouts  
Tim Cloyd, Photography & Layouts







Stephanie and Tia Smith, layouts and sr. directory

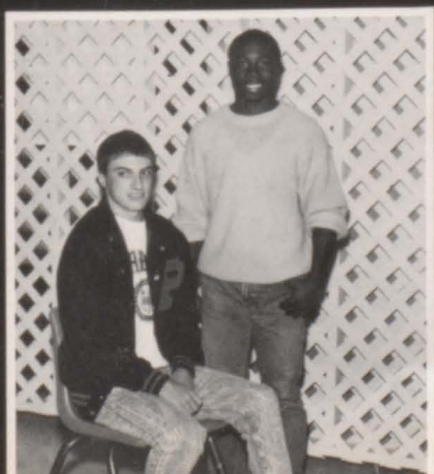

## SPECIAL OLYMPICS

Peabody Special Olympics Club allows athletes to compete in events according to their ability. State and International events enable students to meet people from other places and cultures.

The Seventh International Summer Games were held July 31-August 8, 1987 at the Univ. of Notre Dame and St. Mary's College in South Bend, Indiana. Bobby Stewart and Ross Price won a gold medal for softball.

Peabody Special olympics athletes participated in the Area VII Bowling Tournament Oct. 22 at Paris, Tn. Several won medals.

Steve Williams and Ausborn Ganaway, a former P.H.S. student, competed in a Special Olympics Roller Skating Tournament on Nov. 8, 1987. Steve won two first place medals.

J.  
T.  
G.

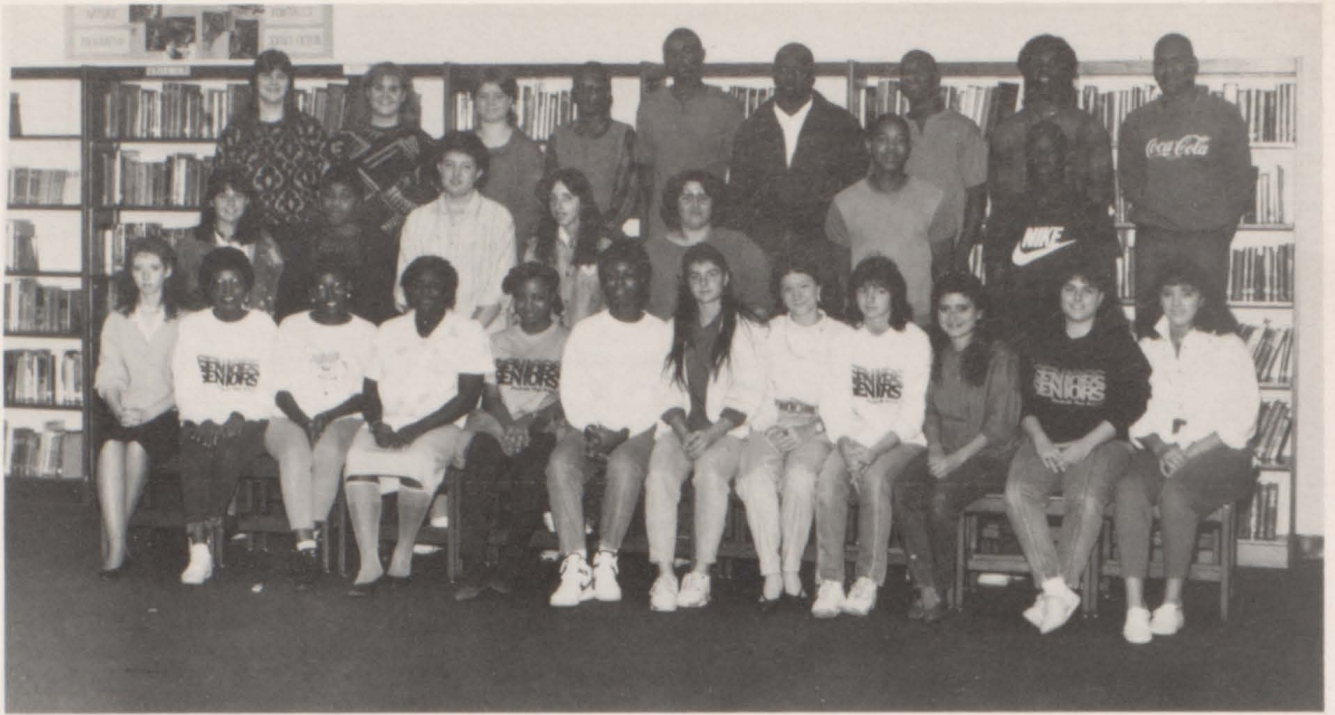

JOBS FOR TENNESSEE GRADUATES

Through Jobs for Tennessee Graduates, a school-to-work preparation program, and Tennessee Career Association, its student organization, seniors get special training in skills and behaviors needed to succeed in the work place.



Officers: Rachelle Ward, president; Colis Long, vice-president; Vickie Jarrett, secretary; Pam Mance, civic affairs; Melissa Rawdon, career preparation.

G.  
B.  
T.





O.  
E.  
A.

### OFFICE EDUCATION ASSOCIATION

On Oct. 2, O.E.A. students went with Special Olympics students to keep score and assist during a practice session before competition on Oct. 22. For several years O.E.A. has assisted Special Olympics as one of their community service projects.

A portable electronic display board was purchased for use in the commons area and at ballgames. It gives information on up-coming events or gives recognition to students and teachers on special occasions. O.E.A. contributed to this purchase.

Regional Competitions were held in March in Jackson. Voting delegates from our club attended State Leadership Conference March 25-27 at Opryland Hotel in Nashville. These meetings encourage our interest in secretarial skills and introduce us to related fields.

Next year the club name will become Business Professionals of America. The name may change, but the goals will be the same.



**OFFICERS:** Lisa Brown, reporter; Patti Trull, vice-president; Sherri Milligan, president; Amanda Russell, parliamentarian; Daphne Ray, treasurer; Laquissa Johnson, secretary.

# FUTURE HOMEMAKERS OF AMERICA



Mrs. Nina Cash  
Advisor



Ruth Ann Gipe, president; Lora Parnell, vice-president; Crystal Shepherd, 2nd vice-president; Kim Gordon, secretary; Susan Dorsett, treasurer; Executive Council: Holly Richardson, DeAnna Tyner, Lisa Edmonds, Advisory Council: Bridget Harper, Tonya Bufford, Lisa Elliott, Rebecca Thomas



Serving special education classes refreshments, making tray favors for Harlan-Morris residents at Halloween, Thanksgiving and Christmas, serving refreshments to teachers and athletic teams, the Honor Your Dad Banquet in Nov., and the Honor Your Mom Banquet in May make us the most active organization in Peabody.

We serve the school, the community and charitable organizations. During initiation freshmen members must bring cup cakes one day and sell them. This year that money went to buy Christmas toys for four needy children.

# FELLOWSHIP OF CHRISTIAN ATHLETES



OFFICERS: Tracy Gibson, Mitzie Branch, Shannon Hawkins, membership council; Rob Dublin, sec./treasurer; Susan Sisk, president; Jason Cox, vice-president.



## DRAMA CLASS

DRAMA CLASS: Jeff Ziegenhorn, Paul Cromley, Brad Rainwater, Tammy Hunt, Jason Scott, Mrs. Donna Carr, advisor, Denise Thetford.





## STUDENT COUNCIL

**OFFICERS:** Greg Cannon, president; Jason Cox, vice-president; Jeff Blankenship, Secretary; Lora Parnell, treasurer; Bridget Harper, historian; Brent Bunch, reporter; John Prince, sergeant-at-arms.



"Let's Keep Pride in the Tide", our motto adopted in August, has been carried out in student activities this year and given us all reason to strut. Student Council members spent long hours organizing the Homecoming activities for Oct. 9. On Nov. 20, the last day of American Ed. Week, we observed Teacher Appreciation Day by serving fruit, sandwiches, chips, cookies and drinks in

the teachers' lounge. Ms. Houston went with us to the Tenn. Assn. of Student Councils Leadership Conference at Camp Cordova Nov. 24, which was hosted by Germantown High. Doug Mansfield, Humboldt football player who was severely injured, was given help with medical expenses by our fund raising project. These are several of the reasons we have "Pride in the Tide".



SENIORS: Greg Cannon, Lora Parnell, Jeff Blankenship, Laquissa Johnson, John Prince, Brent Bunch.



Ms. Glenda Houston

S  
P  
O  
N  
S  
O  
R



JUNIORS: Wesley Johnson, Shannon Hawkins, Mark King, Bridget Harper, Charlie Williams, Jason Cox



FRESHMEN:  
Tori Bechtel, Meg Hartfield, Dianna Chartrand.



SOPHOMORES: Eric Milan, Holly Richardson, Tonya Bufford, Andy Thompson, Chas Weems

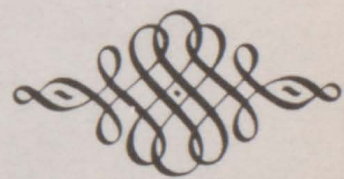

# FUTURE FARMERS OF AMERICA

## F.F.A. EVENTS OF '87-88

- \* 1st Place booth at Gibson Co. Fair
- \* 1st Place Livestock Judging Team at Gibson Co. Fair
- \* 3rd Place Livestock Judging Team in Region
- \* 2nd Place Dairy Judging Team in Region
- \* Competed in Mid-South Fair in Livestock and Dairy Judging Competition
- \* 3rd Place in District III Soil Judging Competition
- \* 3rd Place in District III Parliamentary Procedure Competition

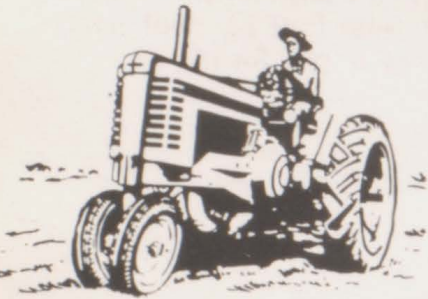

OFFICERS: Bruce Davis, president; Phil Sanderson, parliamentarian; Clay Barrix, vice-president; Terry Campbell, secretary; Lee Epsey, sentinel; Doug Jones, treasurer; Robert Hartfield, 2nd vice-president; Joseph Dudley, historian; Larry Setzer, 3rd vice-president; Mark Gregory, advisor.







OFFICERS: Angela Lewis, president; Kathy Becker, vice-president; Ms. Sylvia Fron, sponsor; Amanda Russell, treasurer; Karen Griffin, reporter; Lisa Rangel, secretary; Sherry Tyner, parliamentarian.



Activities for personal development and community support keep students enrolled in our vocational marketing program busy.

Oct. 15-17 members of Distributive Education Clubs of America assisted Ingram's I.G.A. in celebrating their anniversary. On Nov. 5 several students attended a leadership conference, and in Dec. Santagrams were sold as a fund raising project. Regional Competitions were held Feb. 1. In the spring the annual Employer/Employee Banquet gave student employees a chance to say "Thank You", and the Powder Puff Football Game helped raise money to pay for it.



# ART

We exhibited examples of our best work Oct. 8 in the commons area during Parent/Teacher Conference and at all three banks during American Education Week, Nov. 16-21.



ADVISOR: Mrs. Diane Shaw

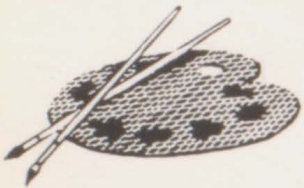

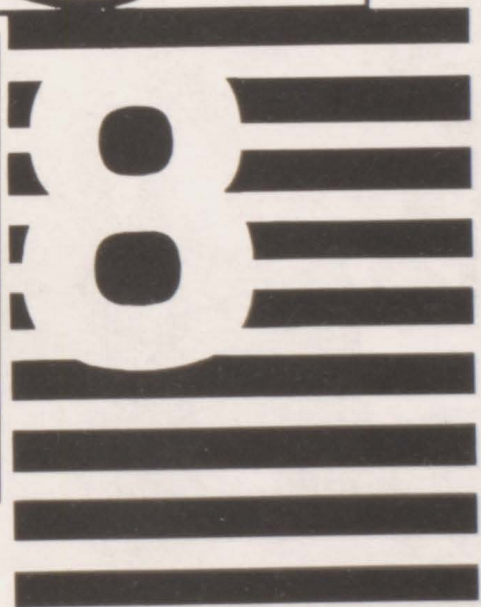
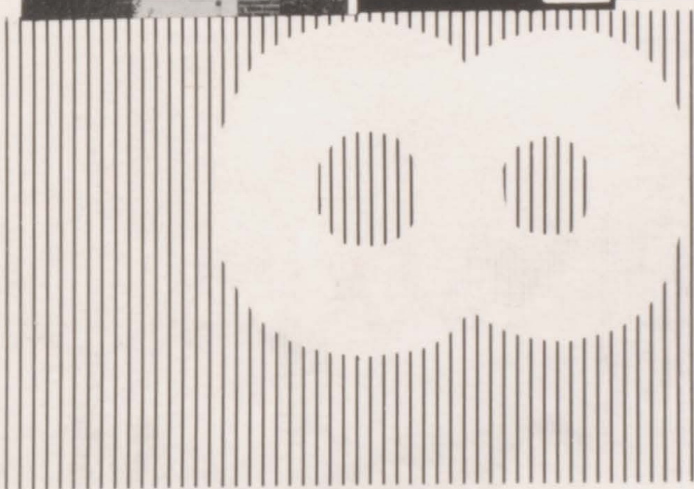
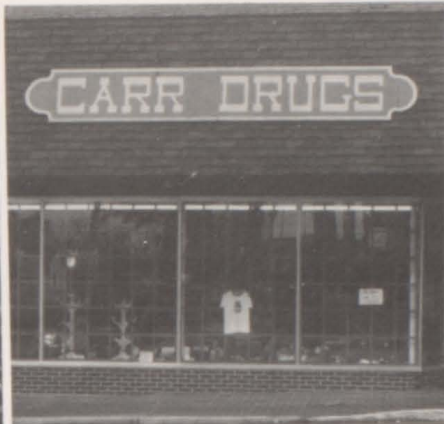

# ONCE THE SCHOOL DAY IS OVER —

many P.H.S. students work in local businesses. These students are employed by ones that have ads in The Golden Torch. These are rewarding experiences for both students and employers.



Best Wishes,  
Seniors Of '88



**WADE ELECTRIC**  
CO. Hwy. 45 By Pass



**West Tennessee  
Business College**

Building new careers  
since 1888

- \*secretarial sciences
- \*clerical/general office
- \*medical & legal  
secretarial
- \*accounting &  
computer
- \*medical office  
assisting
- \*cosmetology
- \*word processing

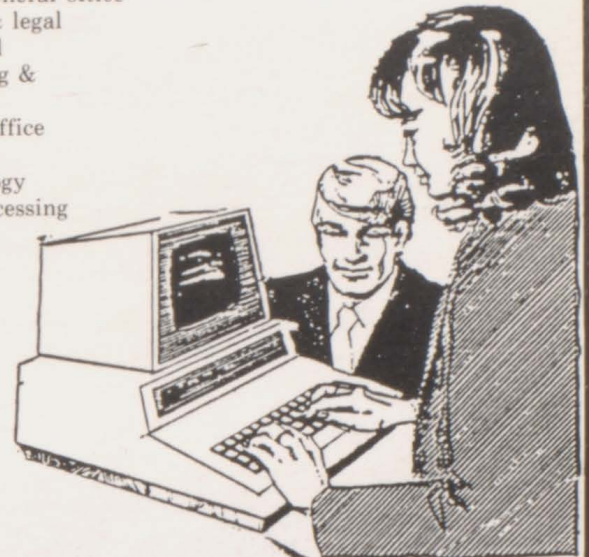

Call Now For More Information  
**668-7240**

1186 Hwy. 45 ByPass Jackson, Tn.



# INGRAM'S INC.

"Your Full Service Supermarket"

855-1916

108 West Armory St.

855-1929

Trenton, TN 38382



Richard Ingram  
President

Jerry Stewart  
Sec. Treasurer

K

# KENT DAUGHTER & SONS FARMS



Growers Of Cotton, Corn, Wheat, Soybeans, Hogs  
And Cattle — Brazil, TN



Congratulations  
P.H.S. Seniors Of '88

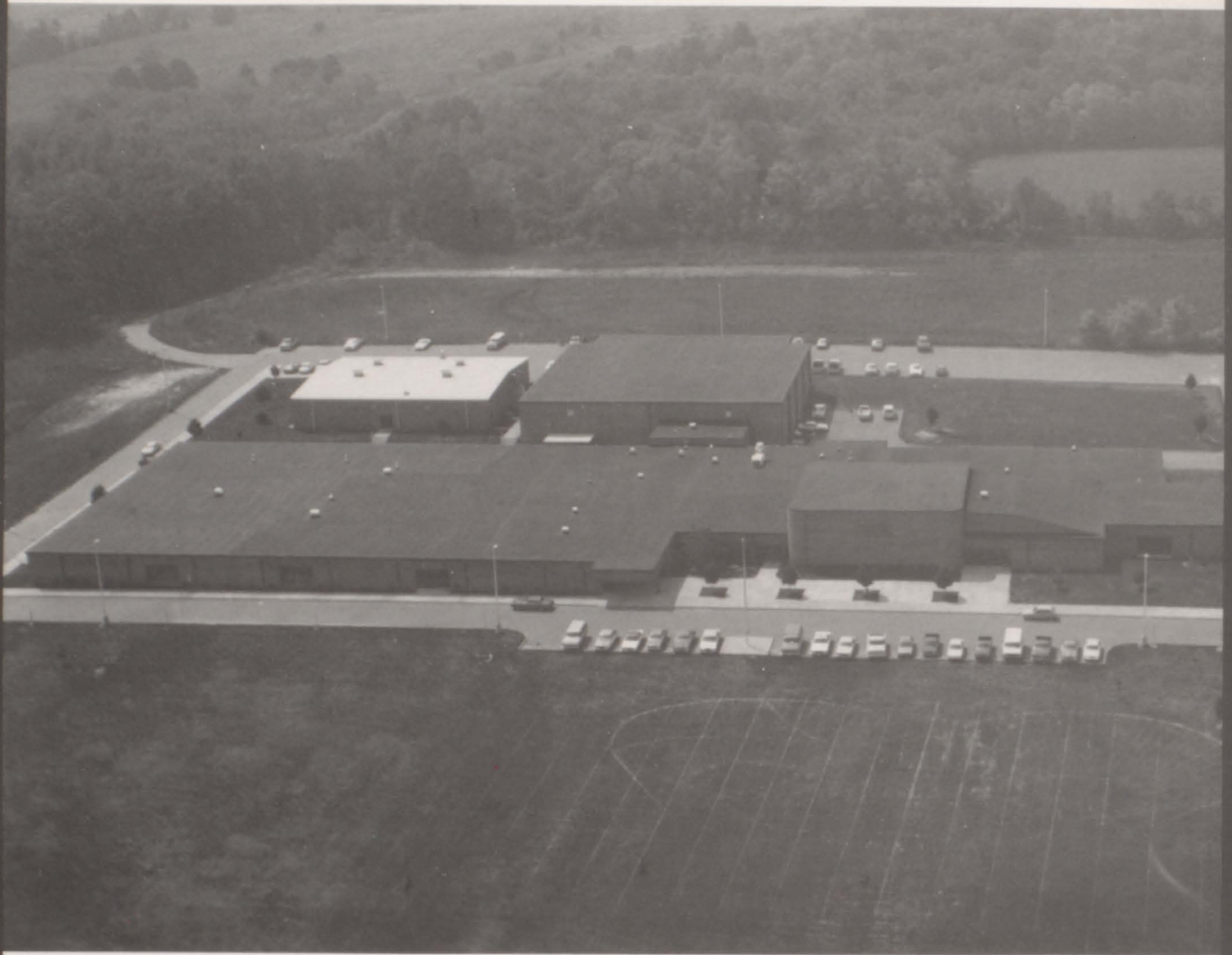

JOE BASS  
Photographer  
617 N. 22nd Ave.

**Bass**  
Studio

Mon.-Fri. 9-5  
Sat. 9-12  
784-8725

P. O. Box 96  
Humboldt, TN 38343





**DEAN FOODS**

P. O. BOX 1623  
JACKSON, TN 38302

**EYECARE CENTER P.C.**



Optometry Clinic — Optic Dispensary  
Davy Crockett Mall  
Trenton, TN



**PHS**  
CITY FLORIST

Band of Gold

106 E. Court St.  
Trenton, TN  
38382

855-9600

Anita Sims  
Doris Humphreys

**Snacks for every taste!**

ALLEN SNACK FOODS  
P.O. Box 1122  
DYERSBURG, TN 38025



Compliments Of  
**TRENTON GIN COMPANY**



Compliments Of  
**PIZZA HUT**

855-4652

**SPOTLIGHT VIDEO**

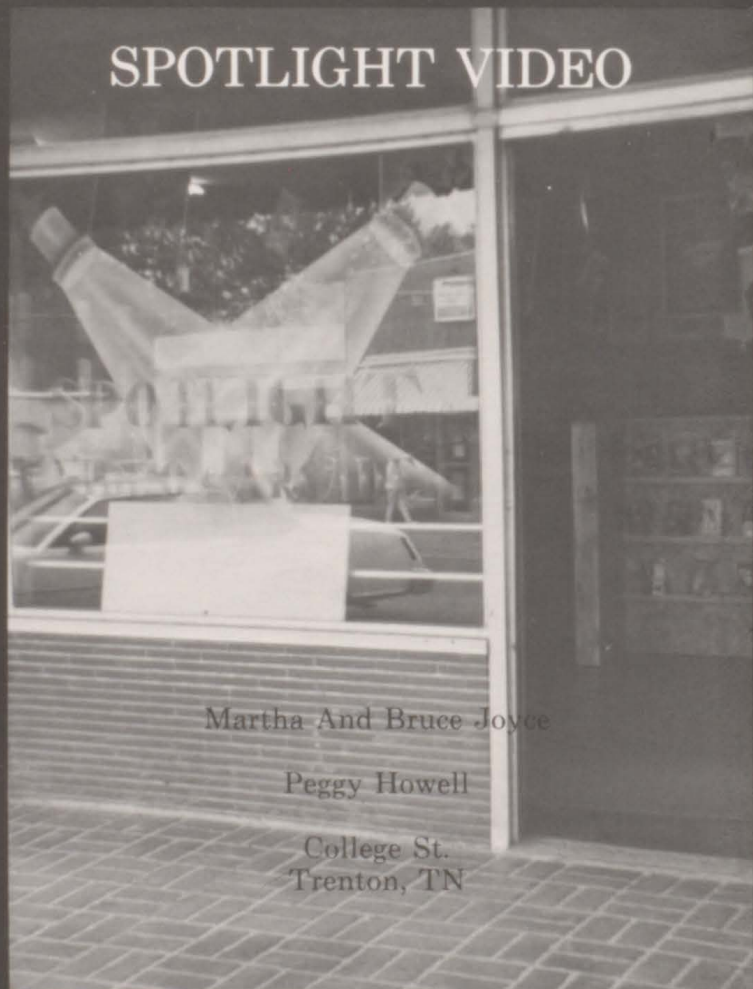

Martha And Bruce Joyce

Peggy Howell

College St.  
Trenton, TN

GIBSON GENERAL HOSPITAL

Wishes Continued Success  
To The Students And Faculty Of

PEABODY HIGH SCHOOL



*Gibson  
General  
Hospital*

Offering You:

The P.C. Care Center  
1 Day Surgery  
24 Hr. Emergency Room  
V.I.P. Admission  
SN Care Unit  
11 Physician Specialties

GIBSON GENERAL HOSPITAL

P.O. Box 488  
Trenton, Tennessee 38382

855-2551



AN AMERICAN HEALTHCARE MANAGEMENT, INC., FACILITY

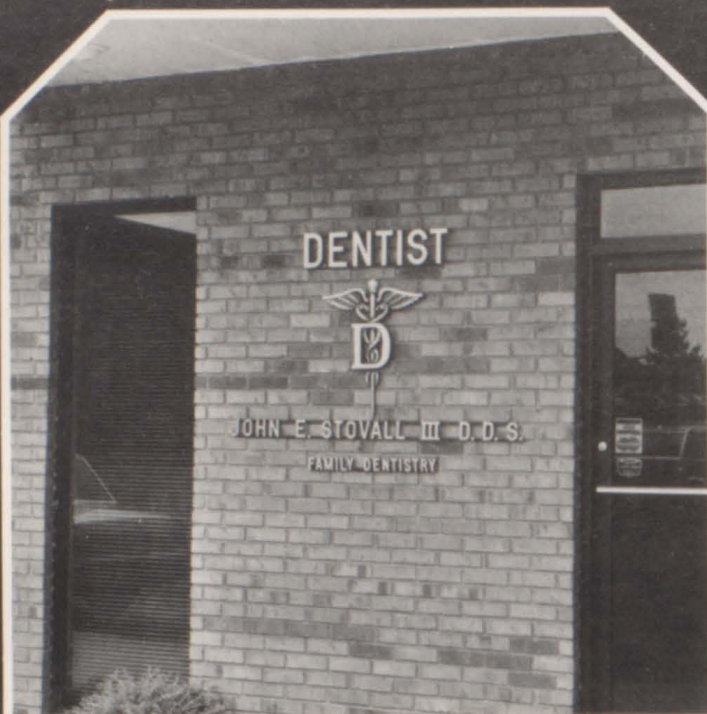

Congratulations On Your Crowning  
Achievements

JOHN E. STOVALL, III, D.D.S.  
124 DAVY CROCKETT MALL  
TRENTON, TENNESSEE 38382  
OFFICE PHONE 855-9114

## DUNCAN'S BODY SHOP



Bobby Duncan

Dyer Highway

855-1188

## TRENTON FLOOR CENTER

Wallpaper, Paint, Carpet,  
Vinyl  
Commercial —  
Residential

Hwy. 45 By-Pass  
Gibson Rd.  
855-0884



SYLVANIA

GIBSON



### FACTORY OUTLET FURNITURE

DAVY CROCKETT MALL  
TRENTON, TENNESSEE 38382  
Phone 901-855-9546

Robert Graves  
Rickey Graves



MADISON COUNTY TRACTOR CO.  
3870 Hwy. 45 N.  
Jackson, TN 38305  
901-668-0330

"Lawn & Garden Is Our Specialty"

## TRENTON MOTEL

901-855-0321

Hwy. 45 W. North  
Trenton, TN 38382

Color Cable T.V. Individual  
A/C And Heating  
Direct Dial Phone  
Suite

Mary's Tea Room With Good  
Southern Food And Buffet

## THOMPSON, BREEDING, DUNN, CRESWELL AND SPARKS

Certified Public  
Accountants

P.O. Box 504  
109 West Court Square  
Trenton, TN 38382  
855-1097

Compliments Of  
WILLIAM P.  
FORTNER, O.D.  
Family Optometry  
Clinic



# FAMILY SHOE STORE

Davy Crockett Mall



"Put Yourself In Our Shoes"

855-3885

Compliments Of

# DOLLAR ALLIANCE

## fruit juice

and refreshing Juice drinks!



500 West Eaton  
Trenton, TN

UP-SY DAISY  
FLOWERS & GIFTS  
855-1479

FLOWERS



For All Occasions

Flowers, Balloons & Gifts

UP-SY DAISY

106 W. Eaton Street  
Trenton, TN 38382

Linda Hickerson  
Home: 784-2157

Virginia Beavers  
Home: 855-2580

Telephone: 855-1479

# CARR DRUGS



"Let Us Guard Your Health"

855-0351

# PHELAN MOTOR CO. INC.



HOME	14	GUEST	17
DOWN	4	TO GO	6
BALL ON	12	QTR	4

32 Years In Sales And Service  
Trenton, TN 38382

We Support The Peabody Golden Tide

BETA UPSILON MU SORORITY





Everything In The World  
For Your Office

## OFFICE WORLD INC.

106 High St. Trenton, TN  
Phones 855-9131 Or 855-2911

Growing Together To  
Serve  
You Better

Nancy M. Hunt James Coble

Compliments Of

## KB SUPPLY COMPANY



Hwy. 45 Trenton  
855-1895

## WAREHOUSE MARKET



Hwy. 45 By-Pass  
Trenton, TN  
855-3634

## TRENTON MY NEIGHBORHOOD

For the past 15 years I've been helping my neighbors here in Trenton protect the things they value with State Farm Insurance. I am proud to support Peabody High School.



STATE FARM INSURANCE COMPANIES  
HOME OFFICES - BLOOMINGTON, ILLINOIS

Charles V. Hill  
Agent

317 E. Eaton Street  
Trenton, Tennessee 38382

Off. Phone: 901 855-0433  
Home Phone: 901 855-1841

# BANK OF TRENTON AND TRUST COMPANY



The Most Important Thing  
We Do Is Serve You



## VOLUNTEER LANDSCAPING

Congratulations Chris And Chris

855-1695

559-4214



Trenton, TN

## CITIZEN'S STATE BANK

Main Office  
Court Square  
Trenton, TN

Member  
FDIC

Hwy. 45  
By Pass  
Branch  
Davy Crockett  
Shopping  
Center



**DUNNAGAN  
FURNITURE**  
204 East Eaton St.  
855-2960  
Howard G. Dunnagan

**TAYLOR GLASS  
AND  
CUSTOM MIRRORS**

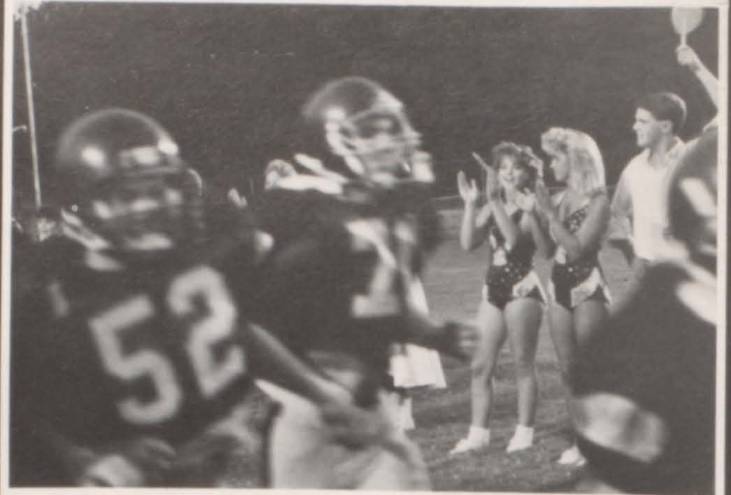

**BEST WISHES  
BILL AND LEE**

**Serving Trenton  
For Thirteen Years**

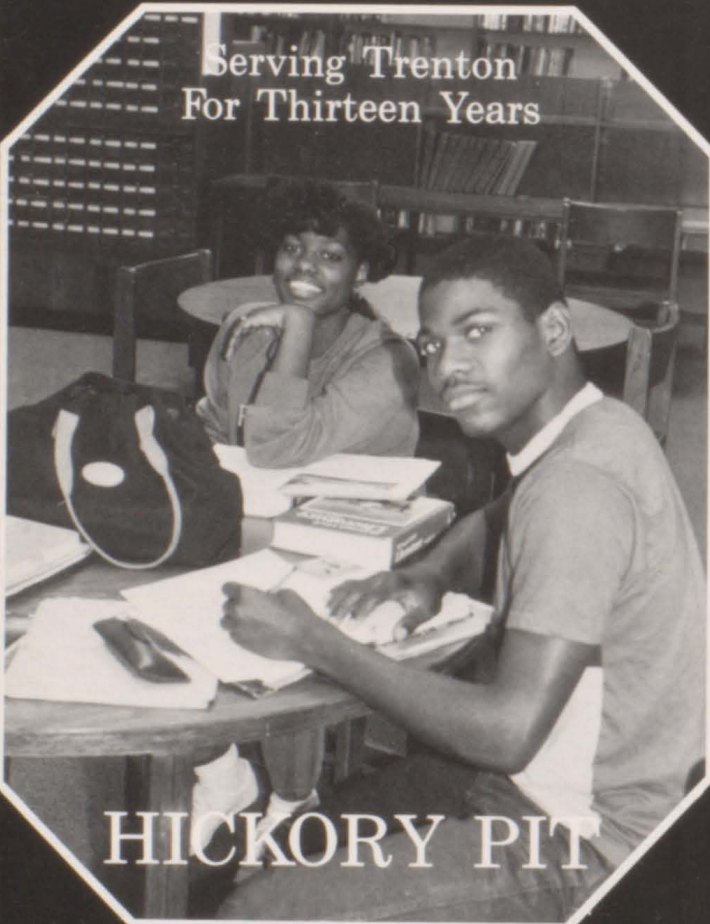

**HICKORY PIT**

**BAKER'S  
RECYCLING CENTER**

**Buying Aluminum Cans**



**Mondays And Saturdays  
9:00 A.M. - 11:30 A.M.**

**855-0240**

THE SONIC CONGRATULATES  
THE CLASS OF '88'!!



SONIC

Hwy 45 By-Pass  
Trenton, TN  
855-0000

HAYS FOODS  
DAVY CROCKETT MALL

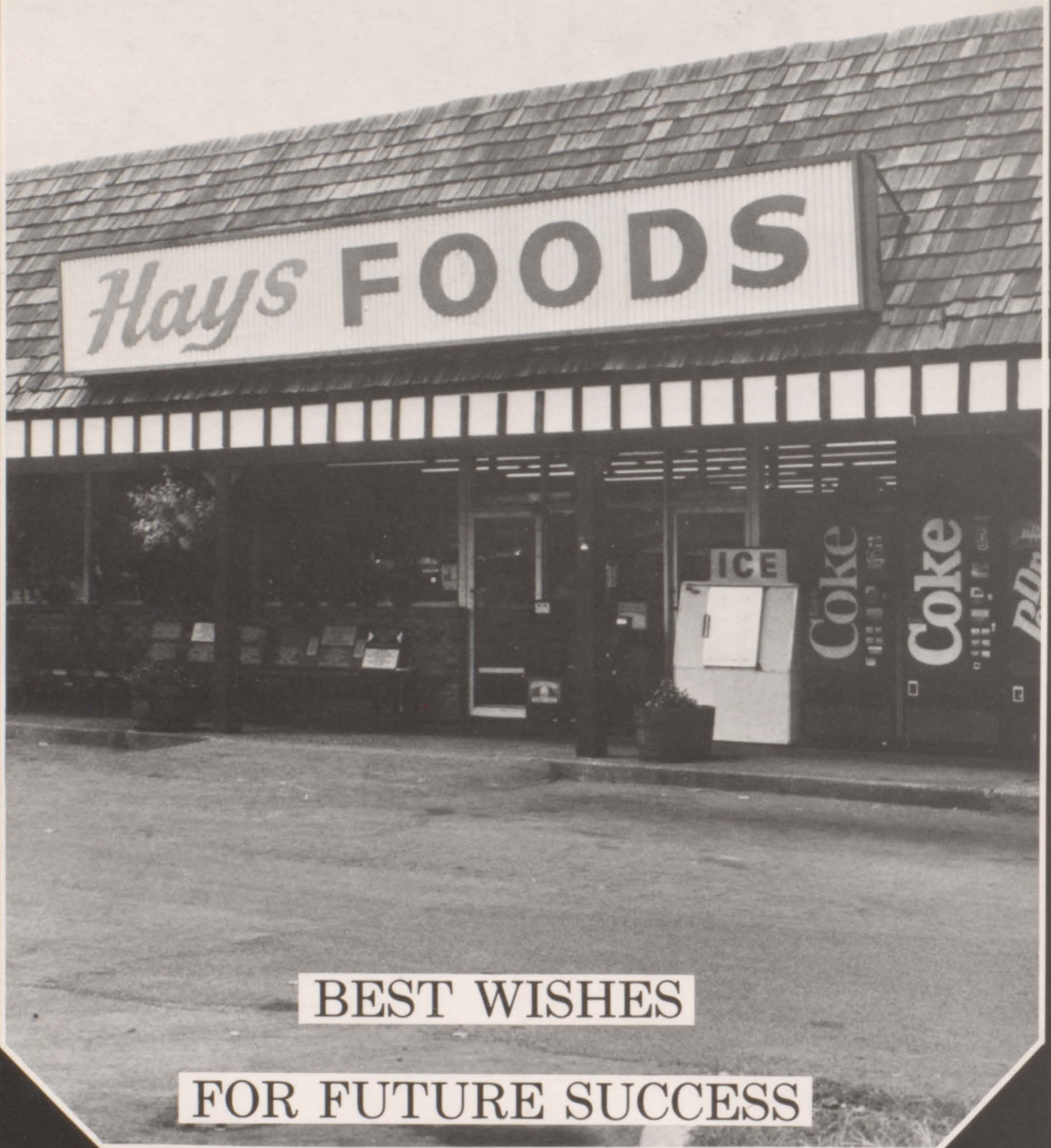

BEST WISHES

FOR FUTURE SUCCESS



**SEWELL CARPET**

(901) 855-9041  
 "QUALITY FOR LESS"

Highway 45 By-Pass  
 at Milan Hwy  
 Trenton, Tennessee 38382



installer has 23 yrs. experience

**PHELAN CANOPY CO.**

Box 171, Trenton, TN 38382  
 855-3818 — Lynn Cole, V. Pres.



Compliments of  
**THE CHIROPRACTIC  
 CENTER**  
 G. Lean King D.C.



1100 High Street  
 Trenton, TN 38382  
 855-4719



**PARTE FEED AND  
 FERTILIZER CO. INC.**

Agri-business Specialists

W. EATON ST.  
 855-1801

# NORTHSIDE GAS STATION

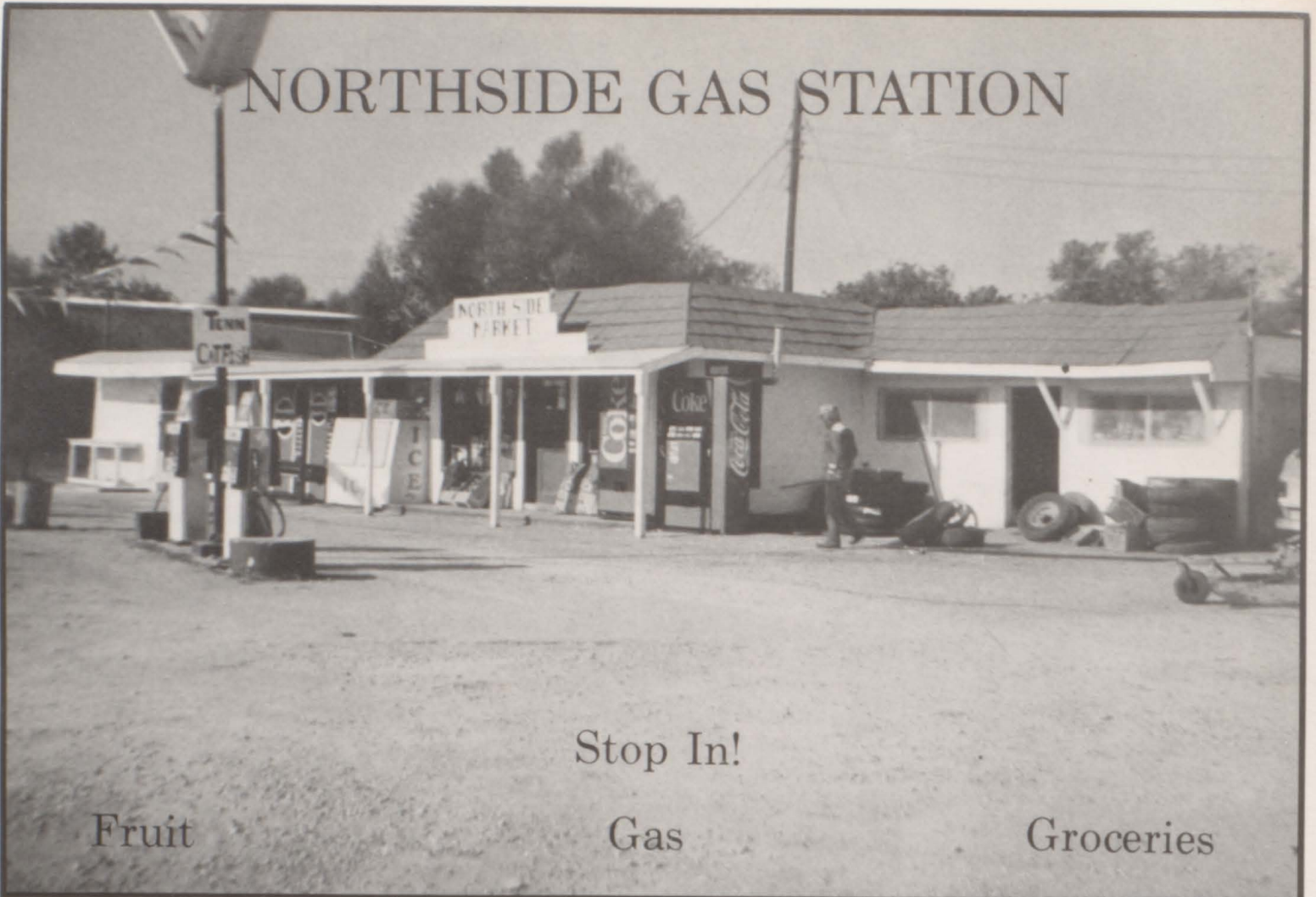

Stop In!

Fruit

Gas

Groceries

Listen To 98 FM!

Trenton, TN  
855-0098

# WLOT 98 FM

*America's Music*



## COTTAGE COLLECTIONS

1006 High St  
Trenton, TN 38382  
855-1616

Gifts — Interiors



# SOUTHERN REALTY

Serving all Gibson County Farm, Residential, Commercial Sales, Appraisals & Rentals

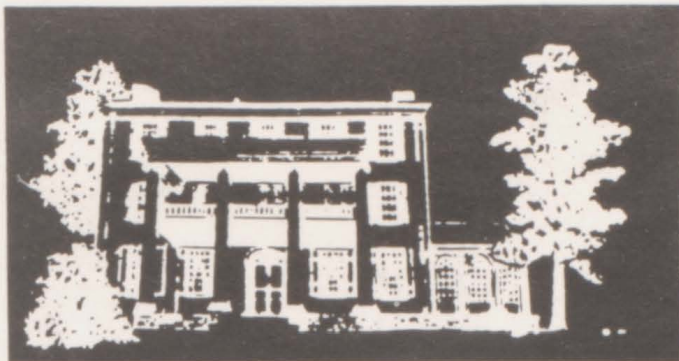

*Martha Dunagan*

*Ann Norman*

**901-855-4585**

100 E. Court St.  
Trenton



COMPLIMENTS  
OF

**BILLY  
SISK**



*Majestic*

*Steak House  
& Pizza*

DAVY CROCKETT SHOPPING  
CENTER

Trenton, TN — 855-4808



Compliments Of

**BROWN  
SHOE**

Trenton Industry  
For 35 Years

Tommie Goodwin,  
Mayor

J. Mahlon Greene  
City Judge

James B. Burress  
City Recorder

Paul R. Cannon  
Alderman

Frank S. Neely  
Alderman

Charles A. Tyner  
Alderman



Charles M. Carr  
Alderman

Leo Manness  
Alderman

George E. Wade  
Alderman

## CITY OF TRENTON

Janice Jones  
Circuit Court Clerk

Josephine Jackson  
County Court Clerk

Hilda Patterson  
Register



Bill Haney  
County Executive

Charles Lovell  
Tax Assessor

Barbara Palmer  
Trustee

## GIBSON COUNTY

Student Council: "Part Of The Pepsi Generation"

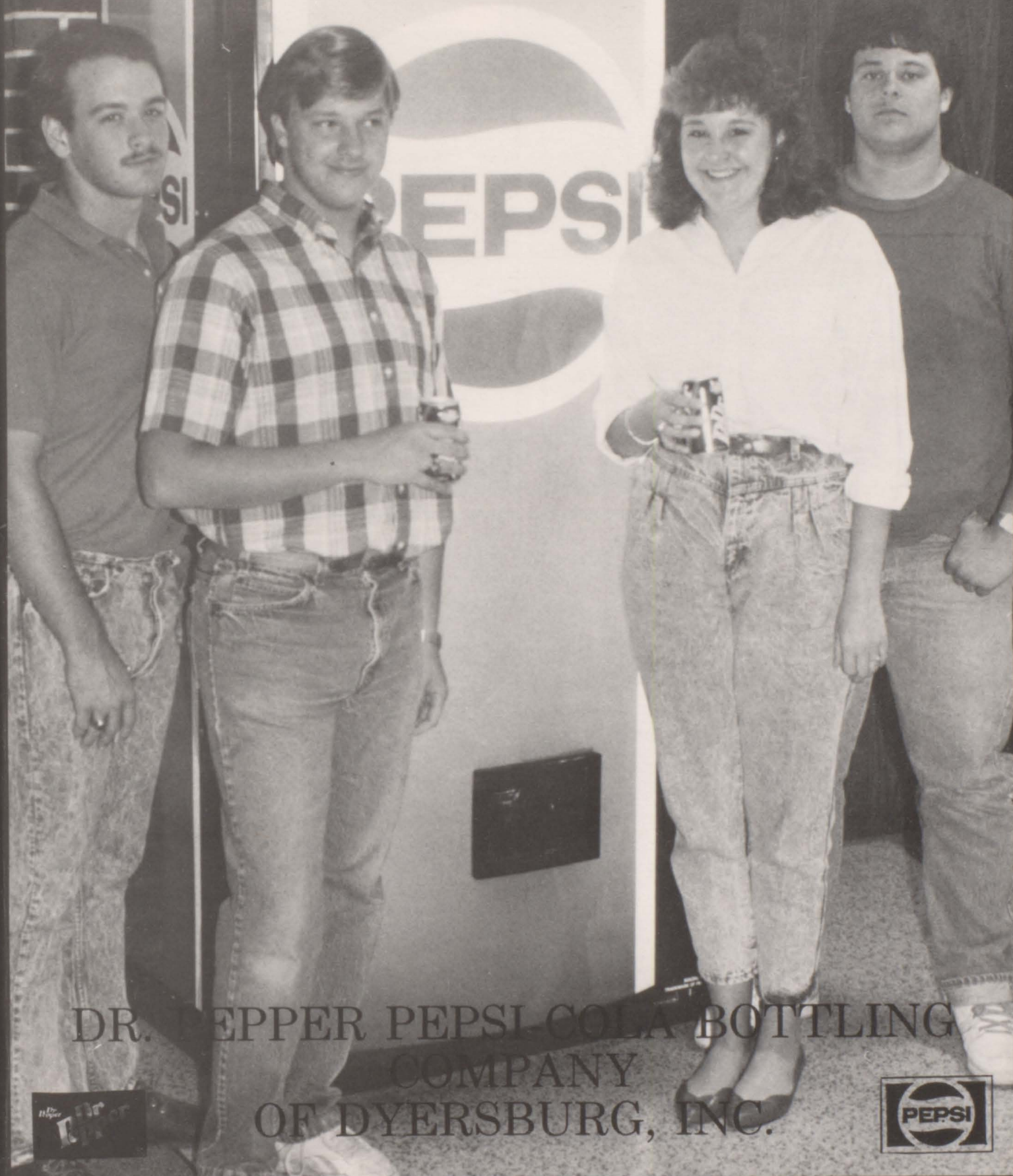

DR. PEPPER PEPSI COLA BOTTLING  
COMPANY  
OF DYERSBURG, INC.



**PHELAN CO.  
INC.**

General  
Contractors

Trenton, TN  
855-4863



Humboldt Center  
Humboldt, Tenn. 38343  
784-6060

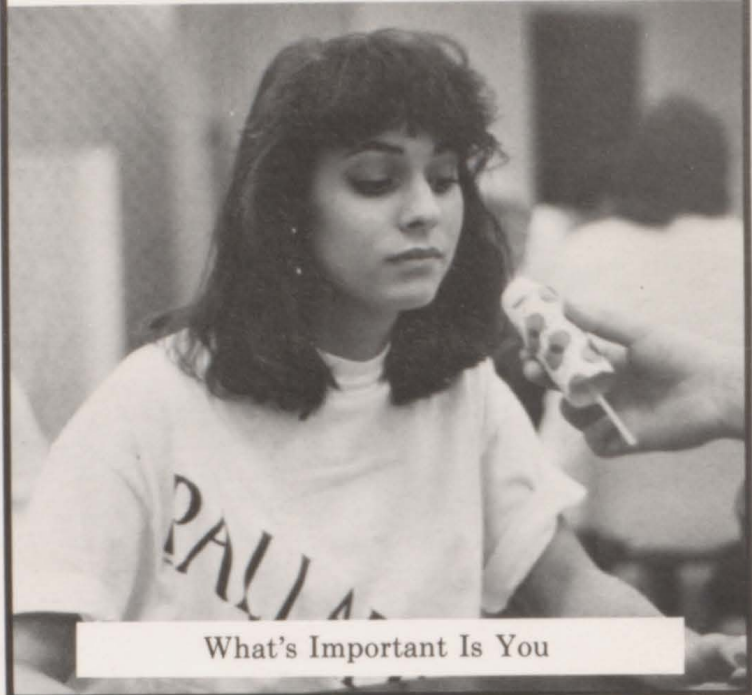

What's Important Is You

Noraine Becton  
Georgia Lou Becton  
Owners

Business — 855-9551  
Home — 855-0786

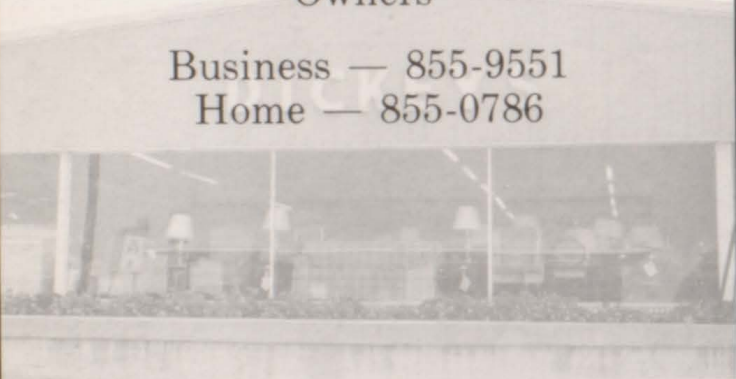

**DICKEY'S**

*"Where Friends Meet"*

Furniture — Hardware

207 West Eaton  
Trenton, Tennessee 38382



**SINGLETON OIL CO.  
INC.**

P.O. BOX 48  
TRENTON, TN 38382-0048



# Pyrotek

Incorporated  
High Temperature  
Materials Specialists  
Manufacturer's Row

Trenton, Tenn.

Compliments Of



## GIBSON COUNTY FARM BUREAU

208 E. Eaton St.  
Trenton, Tn 38382  
855-2591

306 S. 1st St.  
Milan, Tn 38358  
686-3328

Compliments Of



## MARK A. HARPER D.D.S.

855-1053  
2186 Hwy. 45 By-Pass S.  
Trenton, TN

## MERLE NORMAN COSMETICS



Davy Crockett Shopping Center

TRENTON DISCOUNT  
PHARMACY

Davy Crockett Mall



855-2171

TRENTON  
INSURANCE  
CENTER, INC.

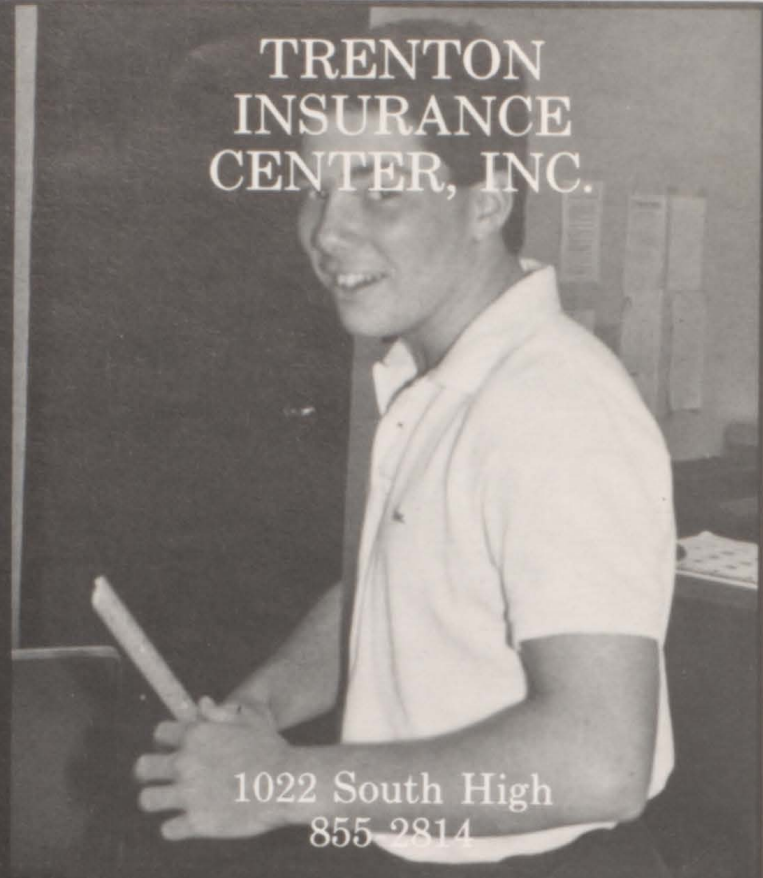

1022 South High  
855-2814

HERALD GAZETTE

111 East 1st Street



We Support The Tide



Davy Crockett Mall



# CENTURY FEDERAL

SAVINGS AND LOAN ASSN.



Savings Accounts and Certificates of Deposit are insured up to \$100,000 for each account by the Federal Savings & Loan Insurance Corporation.

Home Mortgage loans to meet all needs. Century Federal Savings & Loan Association is an Equal Housing Lender serving the West Tennessee area.

**MAIN OFFICE**  
211 S. College St.  
Trenton, Tn 38382  
901-855-2011

**DYERSBURG BRANCH**  
1701 Hwy. 51 Bypass S.  
Dyersburg, Tn 38024  
901-285-2312

**ALAMO BRANCH**  
57 S. Court  
Alamo, Tn 38001  
901-696-4556

**MORTGAGE DIVISION**  
1770 Kirby Parkway  
Memphis, Tn 38138  
901-755-5673



**BAUGUS  
AGENCY  
INC.**

Allstate

Citizens State Bldg.  
Suite 201  
Trenton, TN 38382

Bus. 855-2813  
Res. 784-7638

**DAYLIGHT  
DONUTS**



**DAYLIGHT  
DONUT SHOP**

“Something To  
Crow About”

855-1344  
Trenton, TN 38382

**GEORGE  
RASBERRY  
MOTORS INC.**

HWY. 45 BY PASS  
TRENTON, TN 38382  
855-9005



**Dodge Cars**

**Dodge**

**Dodge Trucks**

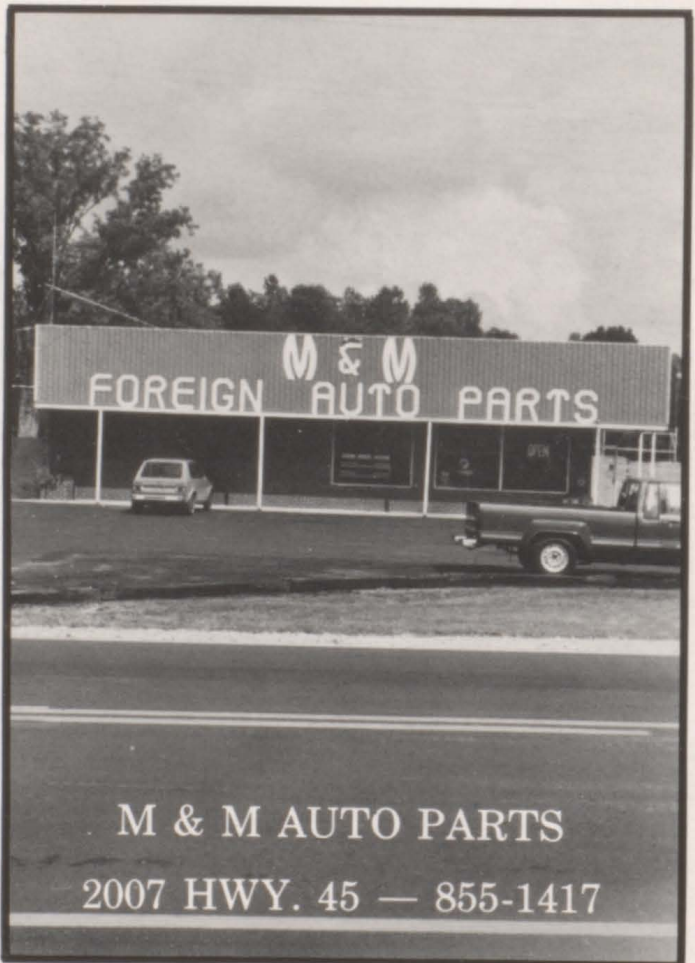

**M & M AUTO PARTS**  
2007 HWY. 45 — 855-1417



# PATSY ANN SHOPPE

Today's Woman, A Shop For Everyone!

Compliments Of ...

DR. GEORGE CULBREATH

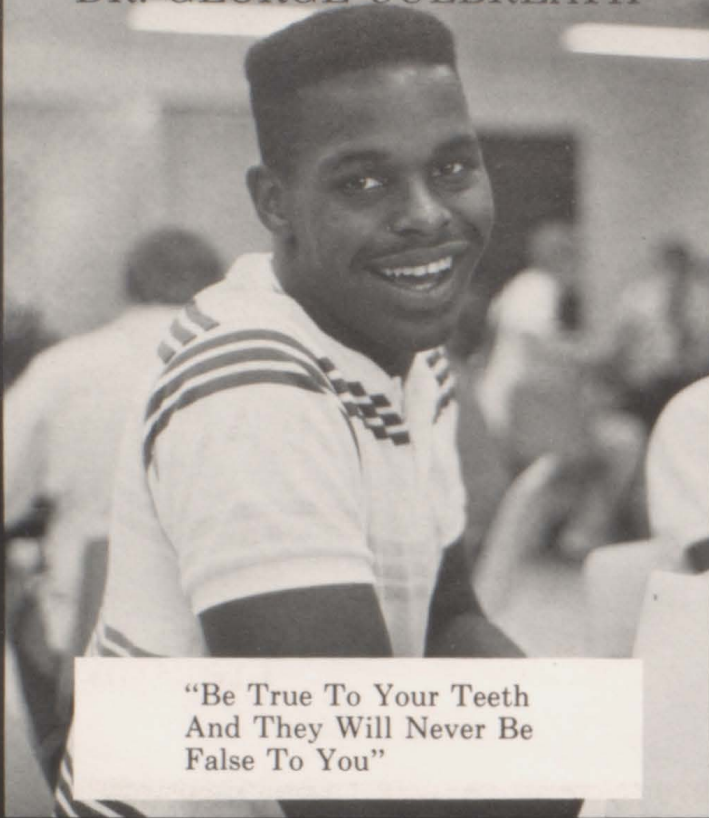

"Be True To Your Teeth  
And They Will Never Be  
False To You"

GIBSON FARMERS  
COOPERATIVE

Quality Farm Supplies'

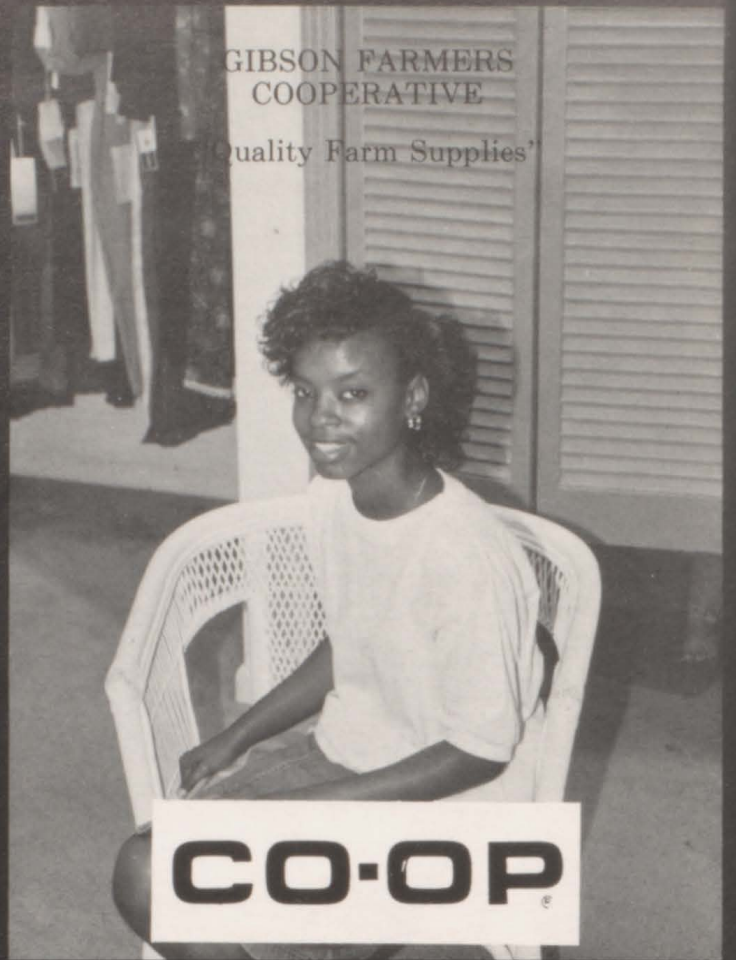

**CO-OP**



Compliments Of

ANDERSON FURNITURE  
AND  
FLOOR COVERING

110 High St., Trenton

FRED'S

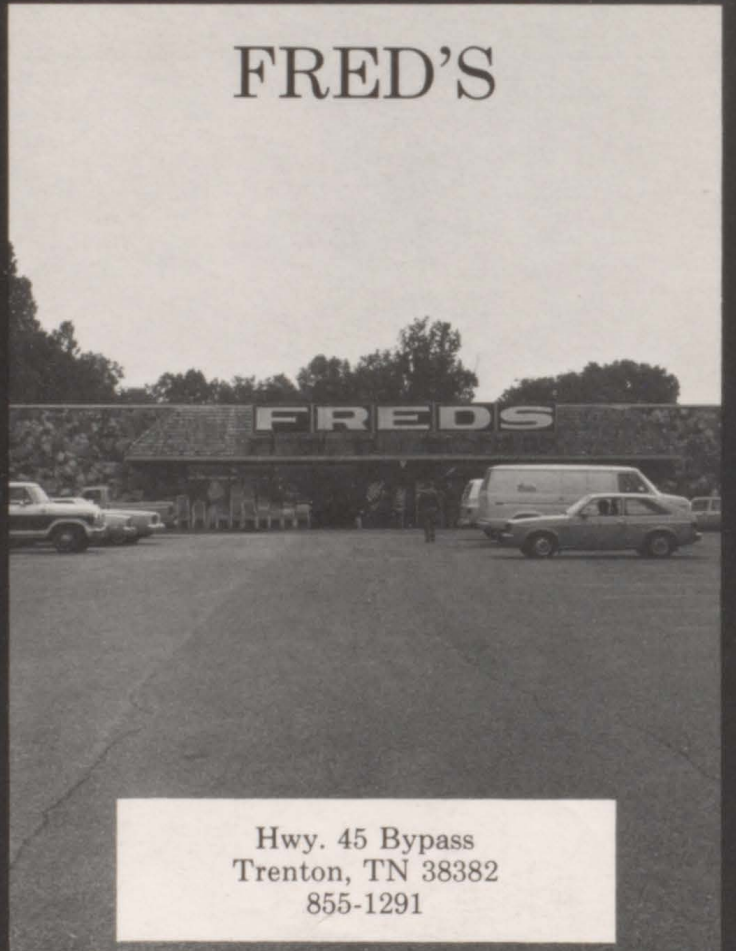

Hwy. 45 Bypass  
Trenton, TN 38382  
855-1291

Compliments Of  
**CITY DRUG**



Reliable RX Service  
Trenton, TN



**LYNDA'S BEAUTY  
SHOP**

Lynda And Kim

1002 College St. Trenton  
855-1845

Compliments Of  
**MILLIGAN'S  
NURSERY**



**CONGRATULATIONS  
SENIORS**

Best Wishes Seniors!

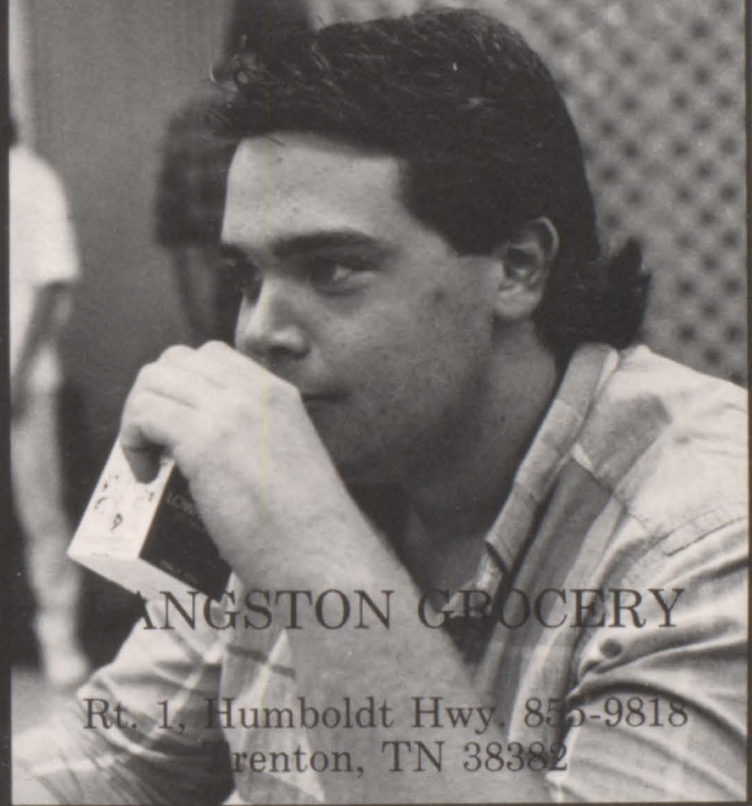

**ANGSTON GROCERY**

Rt. 1, Humboldt Hwy. 855-9818  
Trenton, TN 38382

TRENTON  
INDUSTRIAL  
LAUNDRY

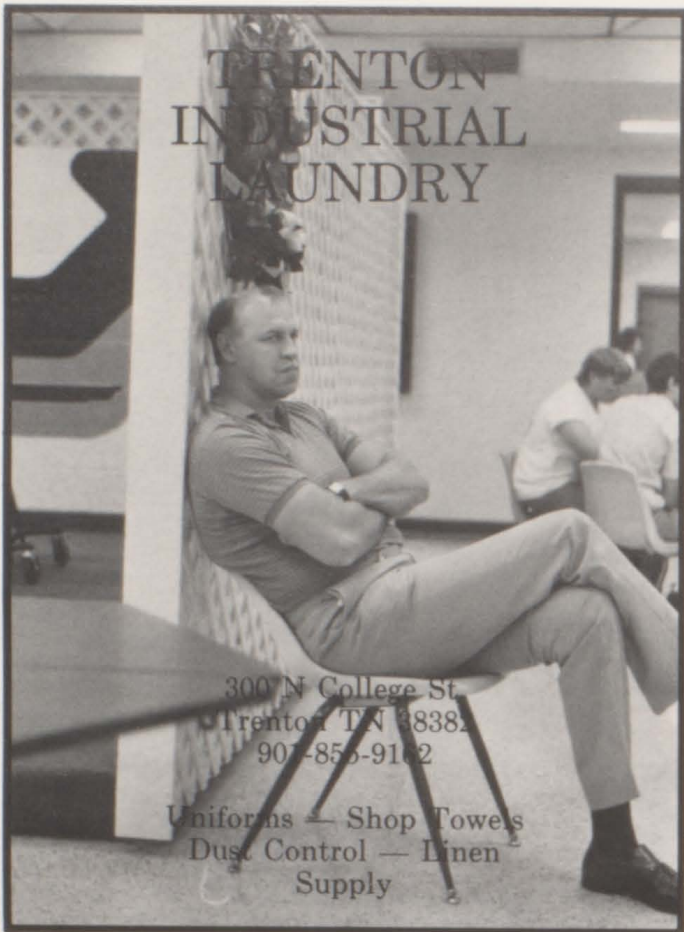

300 N College St.  
Trenton TN 38382  
907-855-9162

Uniforms — Shop Towels  
Dust Control — Linen  
Supply



SHELTON FUNERAL  
HOME

Robert A. Robert M.  
Warner Phillips

SHORT STOP  
FOOD STORES



DELI — GAS — CHICKEN  
ICE — GRO

45 BY-PASS TRENTON

TRENTON  
DAIRY  
QUEEN

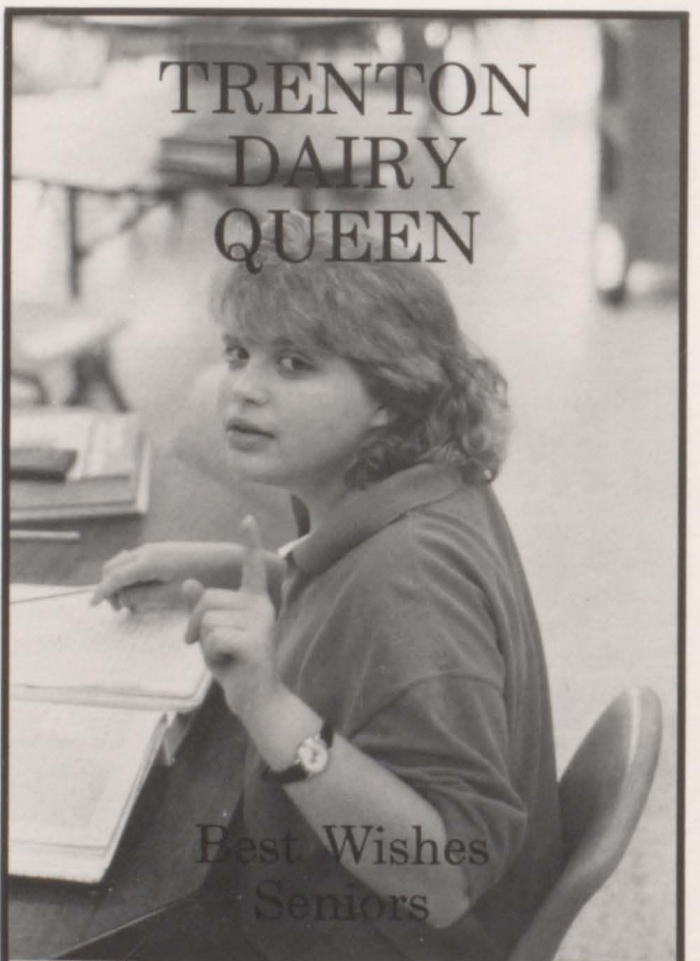

Best Wishes  
Seniors

Make  
**The**  
**Pizza Connection**  
**855-3641**



**Davy Crockett Mall • Trenton**

Sun. - Thurs. 4:00 - 10:00 p.m.  
 Fri. 11:00 a.m. - 12:00 a.m.  
 Sat. 4:00 p.m. - 12:00 a.m.

**EAT-IN • CARRY OUT • OR FREE DELIVERY**

OWNERS -JEANNA CRADDOCK  
 Donna Brown

**D.C. TAYLOR  
 CO., INC.**



120 High St.  
 Trenton, TN 38382

COMPLIMENTS  
 OF



203A Hwy. 45 Bypass  
 Trenton, TN 38382

Compliments of . . .

**T.B.  
 WOOD'S  
 SONS  
 COMPANY**

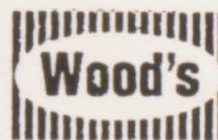

Manufacturer's Row  
 Trenton, TN 38382  
 855-4117

**BANK  
OF  
COMMERCE**

P.O. BOX 187  
TRENTON, TENNESSEE 38382



Main Office 855-0752

Member F.D.I.C.

Southside Branch 855-9568

## MEDICAL HEALTH SPECIALISTS INC.

Specializing In Sales And Rentals Of  
Hospital Equipment For The Home

Court Square  
Trenton, TN  
855-0966



“Where Service Makes The Difference.”

Hwy. 45 By-Pass Trenton, TN  
855-9341

# Build Your Own!

TOM LAWLER'S,  
INC.

The compact Xerox 1025 Marathon copier is versatile to meet your growing needs! Add features now or later.

- Exceptionally high copy quality
- Fast, delivers up to 21 copies per minute
- Desk-top sized, just 24" square

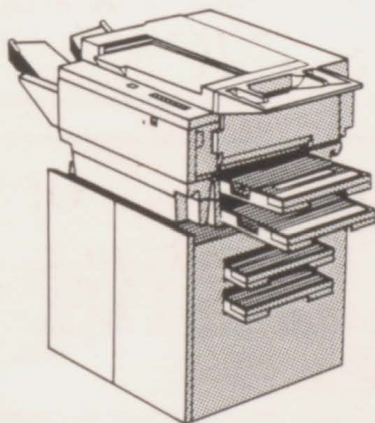

- by 11" high
- Semi-Automatic Document Handler available
- Options include: Reduction/Enlargement, 10-bin Sorter, Three-Tray Feeder, Color Copying and more

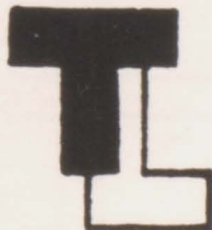

SINCE 1919



1-800-372-8358  
JACKSON, TENNESSEE 38302-1667  
POST OFFICE BOX 1667

# SUPPORTERS

CAROL'S PERSONAL TOUCH

PAM AND NORMA'S



BELL APPLIANCE

CHARLIE'S RADIATOR SHOP

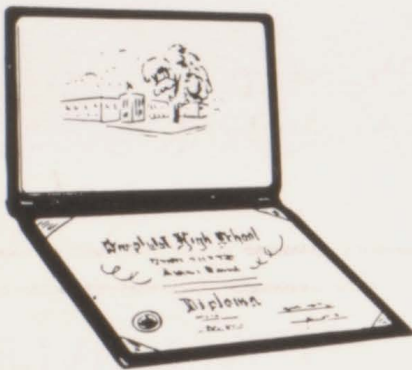

*The Accent House*

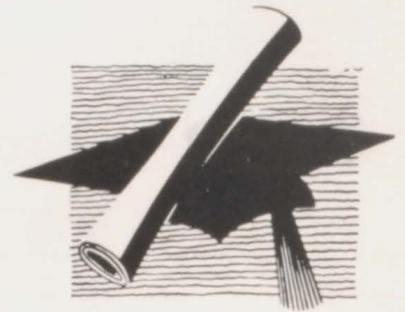

EVEREADY AUTO PARTS

FORUM HOSPITAL AND  
CONVALESCENT CENTER

## One of a Kind

HIGHWAY 54 SALVAGE, INC.

COMPACT CAR PARTS



# PATRONS

Trenton  
Animal  
Clinic



Crim  
Auto  
Parts

Johnsey's

Adam's House



West End  
Tire Company

Trenton  
TV And Cable



Trenton  
Livestock

George's  
Flowers



Silverblatt's

Jennifer's

Hockaday  
And  
Yarbrough



C & E  
Party  
Shop

# A TRIBUTE . . .



Congratulations  
To our daughter  
Mitzie Reneé Branch  
And the graduating class  
of 1988  
Mr. and Mrs. Sonny  
Lane and Mr. Jerry  
Branch

Congratulations  
To our daughter  
Elizabeth Jane Brown  
And the graduating class  
of 1988  
Mr. and Mrs. Wendell R.  
Brown

Congratulations  
To our son and brother  
Kevin Burress  
And the graduating class  
of 1988  
Mr. and Mrs. Charlie  
Burress, Carol Gerard,  
and Jason Burress

Congratulations  
To our son  
Tim Cloyd  
And the graduating class  
of 1988  
Tommy and Linda  
Vaughn

Congratulations  
To our daughter  
Susanne Coffman  
Both of us are very  
proud of you.  
We hope for you a great  
success in the future.  
Mr. and Mrs. Larry  
Coffman



Congratulations  
To our daughter  
Crystal Coleman  
And the graduating class  
of 1988  
Mr. and Mrs. Frank  
Coleman

Congratulations  
To our daughter  
Susan Dorsett  
And the graduating class  
of 1988  
Mr. and Mrs. Derrell  
Dorsett

Congratulations  
To our son and brother  
Rob Dublin  
And the class of "88"  
Mr. and Mrs. Keith  
Dublin, Lisa, and Scott

Congratulations  
To our daughter  
Erika Edwards  
And the graduating class  
of 1988  
Mr. and Mrs. Douglas  
Seward

Congratulations  
To our daughter  
Stephanie Goodwin  
And the graduating class  
of 1988  
Mr. and Mrs. Tommie  
Goodwin

ConGRADulations  
To our son  
Eddie Graves  
Love,  
Mother and Daddy

Congratulations  
To our daughter  
Michelle Hickerson  
And the graduating class  
of 1988  
Mr. and Mrs. Glyn  
Hickerson

Congratulations  
To our son and brother  
Bill Hodges  
And the class of 1988  
Love,  
Mom, Dad, Franky, and  
Winter

Congratulations  
To our daughter and  
sister  
Jeannie Kent  
And the class of 1988  
Love,  
Mom, Dad, Brad, and  
Matt Kent

Congratulations  
To our daughter  
Sherri Milligan  
And the graduating class  
of 1988  
Sammy and Susie  
Milligan



Congratulations  
To our son  
Gavin Orgain  
And the graduating class  
of 1988  
Mr. and Mrs. Harold  
Orgain

Congratulations  
To our daughter  
Lora Parnell  
And the graduating class  
of 1988  
Mr. and Mrs. Jack  
Parnell

Congratulations  
To our daughter  
Denise Thompson  
And the graduating class  
of 1988  
Harold and Beth  
Thompson

Congratulations  
To our daughter  
Kim Wade  
And the graduating class  
of 1988  
Mr. and Mrs. Gene Wade

Congratulations  
To our son  
Michael Wallsmith  
And the graduating class  
of 1988  
Mr. and Mrs. Mike  
Wallsmith



... WITH LOVE

# SENIOR DIRECTORY

GREG ABBOTT: Freshman — Art Club, Football, Spanish Club; Sophomore — OEA; Junior — DECA; Senior — DECA

FRANK ANTHONY: Freshman — Band, First chair All-West Tennessee Junior High Band, First chair Quad — State Honor Band, Outstanding Freshman Musician, Physical Science Award, World History Award; Sophomore — Band, Eighth chair All-West Tennessee Band, Beta Club, English Award; Junior — Band, First chair All-West Tennessee Band, Third chair All-State Honor Band, Beta Club, Economics Award, Math Club, Science Club, UTM Honor Band; Senior — Band — Captain, UTM Honor Band, Beta Club, Math Club, Most Likely To Succeed, Outstanding Senior, Science Club, Top Ten-Valedictorian.

JAY ARNOLD: Sophomore — FFA; Junior — FFA, Senior — FFA.

RHONDA ASHLEY: Freshman — FHA, Perfect Attendance; Sophomore — FHA, OEA, Spanish Club; Junior — Band, FHA, OEA; Senior — Art Club, Band, FHA, JTG.

SONYA BAILEY: Freshman — Band-rifle corp, Basketball, Spanish Club, Tennis; Sophomore — Band-rifle corp, Basketball, Tennis; Junior — Band-rifle corp, Basketball, FCA, Tennis; Senior — Band-rifle corp captain, FCA, Math Club, Tennis.

CARLA R. BARNES: Freshman — FHA; Sophomore — FHA; Junior — OEA; Senior — Co-op, OEA.

ANGELIA LENORA BARNETT: Freshman — Basketball, Spanish Club; Sophomore-Band-flag corp, Basketball Manager; Junior-Band-flag corp, Basketball Manager; Senior-Band-flag corp, Basketball Manager.

CLAY BARRIX: Freshman — FFA, FHA; Sophomore — FFA; Junior — Art Club, FFA — Reporter; Senior — Art Club, FFA — Vice-president.

KATHY BECKER: Freshman — FHA, Spanish Club; Sophomore — FHA, OEA; Junior — FHA, OEA; Senior — DECA — Vice-president.

SUSAN BELL: Freshman — Band, FHA, Solo and Ensemble Superior Rating; Sophomore — Band, Solo and Ensemble, Junior — Band, Solo and Ensemble Superior Rating, DECA; Senior — Band, Solo and Ensemble Superior Rating, Math Club, Outstanding Senior, Teacher's Aide.

JEFF BLANKENSHIP: Freshman — Band, All-West Tennessee Junior High Band, Quad-State Honor Band, Solo and Ensemble — Superior Rating, Beta Club, Honors Banquet; Sophomore — Band, All-West Tennessee Band, Quad-State Honor band, Stage Band, Solo and Ensemble — Superior Rating, Beta Club, Honors Banquet, Student Council; Junior — Band, All-State Honor Band, All-West Tennessee Band, Quad-State Honor Band, Stage Band, Solo and Ensemble — Superior Rating, UTM Honor Band, Beta Club, Boys' State Alternate, Honors Banquet, Math Club, Science Club, Student Council — Secretary; Senior — Academic Decathlon Team, Band, Pep Band, Stage Band, Beta Club, Elk's Student of the Month, Math Club — President, Most Dependable, Outstanding Senior, Science Club — Secretary, Student Council — Secretary, VFW Voice of Democracy — 2nd place, Top Ten — Salutatorian.

MITZIE BRANCH: Freshman — Art Club, Basketball, Basketball Pro-work Award, FHA, Tennis; Sophomore — Band-rifle corp, Beta Club, District Tennis Team, Honors Banquet, Tennis; Junior — Band-rifle corp, Basketball camera-man, Beta Club, District Tennis Team, FCA, Honors Banquet, Powder Puff Football, Science Club, Tennis; Senior — Band-rifle corp, Basketball camera-man, Beta Club, District Tennis Team, FCA-Membership Council, Golden Torch Staff-Lay-out Editor, Honors Banquet, Math Club, Most Original, Outstanding Senior, Powder Puff Football, Science Club, Tennis.

ELIZABETH JANE BROWN: Freshman — Band, FHA; Sophomore — Band, Honors Banquet; Junior — Band, Solo and Ensemble Superior Rating, Math Club, OEA; Senior — Band, Beta Club, DAR Good Citizen Award, Math Club, Most Talented, Science Club.

HAROLD BROWN: Freshman — Basketball; Sophomore — Basketball — Most Improved, Junior — Basketball, Most Rebounds, Boys' State Delegate; Senior — Basketball.

LISA C. BROWN: Freshman — FHA, Spanish Club; Sophomore — OEA; Junior — DECA, OEA; Senior — FHA, OEA — Reporter, TCA.

KEITH BUCHANAN: Freshman — Art Club, FFA; Sophomore — Art Club, FHA, Tennis; Senior — TCA.

BRENT BUNCH: — Beta Club, Class Vice-President, FFA — FFA Member of the Year, Football, Honors Banquet, Student Council; Sophomore — Beta Club, Class President, FFA, Football, Hugh O'Brien Youth Delegate, Honors Banquet, Letterman's Club, Student Council; Junior — Beta Club, Boys' State Alternate, FCA, Football, Coca-Cola Golden Helmet Award, Best Offensive Lineman, 2nd Team All-district Linebacker, Math Club, Perfect Attendance, Science Club, Student Council — officer; Senior — Beta Club, FCA, Football, Best Defensive Back, 2nd Team All-district Linebacker, Honors Banquet, Math Club, Outstanding Senior — Science Club, Student Council — officer, Top Ten Percent.

KEVIN BURRESS: Freshman — FFA; Sophomore — FFA — Diversified Crop Production Award; Junior — FFA, Science Club; Senior — FFA.

MARY CANADA: Freshman — Basketball, Beta Club, Black and Gold Staff, FHA — 3rd Place in FHA Honor your Mother Essay, Honors Banquet; Sophomore — Beta Club, Honors Banquet, OEA; Junior — Beta Club, DECA. Honors Banquet, Math Club, OEA; Senior — Beta Club, FHA, Honors Banquet, Math Club, Top Ten Percent.

GREG CANNON: Freshman — Baseball, Basketball, Football, Honors Banquet, Spanish Club, Student Council; Sophomore — Baseball, Beta Club, Football, Honors Banquet, Letterman's Club, OEA, Student Council; Junior — Baseball, Beta Club, FCA, Football — Best Offensive Back Award, Math Club, Perfect Attendance, Science Club, Student council; Senior — Academic Decathlon, Baseball, Beta Club, FCA, Football — Most Valuable Player, Honorable Mention All District Team, Honors Banquet, Math Club, Outstanding Senior, Science, Club, Student Council President.

AL CLARK: Freshman — FHA; Sophomore — FFA; Junior — DECA, GBT; Senior — GBT.

TRICIA CLARK: Freshman — Cheerleader — Captain, FHA, Spanish Club, Sophomore — Football Cheerleader, Honors Banquet,

OEA, Letterman's Club; Junior — Beta Club, FCA, Football Cheerleader, Girls' State Delegate, Honors Banquet, Math Club, OEA — National Voting Delegate, Science Club; Senior — Beta Club, Honors Banquet, Math Club, Most Dependable, Science Club.

TIM CLOYD: Freshman — Art Club, FFA, Honors Banquet; Sophomore — Art Club, Honors Banquet; Junior — Beta Club, Honors Banquet, Math Club, OEA — Regional Typing Contest, Perfect Attendance, Science Club; Senior — Beta Club, Golden Torch Staff, Honors Banquet, Math Club, Science Club.

SUZANNE COFFMAN: Freshman — Cheerleader, Class Secretary, FHA, Homecoming Representative, Majorette, Student Council, Tennis; Sophomore — Cheerleader, FHA, Majorette, Tennis; Junior — FCA, Golf, Majorette, Tennis; Senior — FCA, Golf, Head Majorette, Math Club, Tennis.

CRYSTAL COLEMAN: Freshman — Beta Club, Black and Gold Staff, Cheerleader, FHA, Honors Banquet, Spanish Club; Sophomore — Beta Club, Football Cheerleader, Golden Torch Staff, Golf, Honors Banquet, Letterman's Club, OEA; Junior — Beta Club, FCA — Vice-President, Football Cheerleader, Golden Torch Staff, Golf, Honors Banquet, Math Club, OEA, Science Club; Senior — Beta Club, Class Secretary, FCA, Golden Torch Staff, Golf, Honors Banquet, Math Club, Science Club.

TERESA COX: Freshman — Basketball, FHA; Sophomore — Band — Most Improved Sophomore Award, Basketball; Junior — Band, Basketball; Senior — Basketball, Homcoming Representative.

PAUL CROMLEY: Freshman — Band, Jazz Band, Spanish Club; Sophomore — Band, Tennis; Junior — Academic Decathlon, Art Club, Band, FCA, Honors Banquet, Tennis; Senior — Art Club, Band, Drama Club, FCA, Science Club, Tennis.

#### TIM DAVIS

BRUCE DAVIS: Freshman — FFA; Sophomore — FFA; Junior — FFA — Chapter Sentinel, Senior — FFA — Chapter President, OEA.

SUSAN DORSETT: Freshman — Band, FHA; Sophomore — Band, FHA; Junior — Band, FHA — Treasurer; Senior — DECA, FHA — Treasurer; Golden Torch Staff.

#### ANGELA DOWDY

ROB DUBLIN: Freshman — FFA — Greenhand Award, Football, Spanish Club; Sophomore — Baseball, FFA — Parliamentary Procedure Team, Golf, Letterman's Club; Junior — Art Club, Baseball, FCA, Football, Honors Banquet, Science Club; Senior — Art Club, Baseball, FCA — Secretary/Treasurer, Football, Math Club.

MIKE DUBRULE: Freshman — Beta Club, FFA; Sophomore — Letterman's Club, OEA — Intro. VOE Parliamentarian, Tennis; Junior — Class Secretary, FCA, Golden Torch Photographer, Tennis; Senior — FCA, Tennis, Wittiest.

JOSEPH ALLAN DUDLEY: Freshman — FFA; Sophomore — FFA; Junior — DECA Parliamentarian, FFA — National Award in Turf and Landscape Management; Senior — DECA, FFA.

ERIKA EDWARDS: Freshman — Band, Stage Band, Solo and Ensemble Excellent Rating, All West Honor Band, Basketball Manager, Beta Club, FHA, Honors Banquet; Sophomore — Band, Stage Band, Solo and Ensemble Superior Rating, Quad State, Beta Club, FHA, Honors Banquet; Senior — Band — Section Leader, Stage Band, Beta Club, Early Graduation, FHA, Honors Banquet, Math Club, Top Ten Percent.

SCOTT EDWARDS: Freshman — Baseball, Football; Sophomore — Baseball, Football, OEA — Intro. VOE Vice-president; Junior — GBT; Senior — Art Club, GBT.

CHARLIE ELGIN: Freshman — Beta Club, Football, FFA; Sophomore — Algebra I Award, Beta Club, Football, FFA, Golf; Junior — Baseball, Beta Club, FCA, FFA, Golf, Math Club, OEA, Science Club; Senior — Baseball, Beta Club, FCA, FFA, Golf, Math Club, OEA.

ROBBIE ELLIOTT: Freshman — FHA, Perfect Attendance; Sophomore — FHA, OEA; Junior — Art Club, FHA; Senior — Art Club, FHA.

KEITH FETTERS: Freshman — FFA — Greenhand Award, Sophomore — FFA; Junior — Art Club, GBT; Senior — Art Club, GBT.

BILLY FRON: Freshman — Band, Solo and Ensemble Superior Rating; Sophomore — Band, Solo and Ensemble Superior Rating, Geometry Contest 3rd Place Regional, Science Club; Junior — Academic Decathlon — Silver Metal in Science, Band, Solo and Ensemble Superior Rating, Beta Club, Boys' State Delegate, Math Club, V.F.W. 1st place Voice of Democracy Contest Local and District; Senior — Academic Decathlon, Band, Solo and Ensemble Superior Rating, Beta Club, Math Club, V.F.W. 1st Place Voice of Democracy Contest Local.

DOUG GANAWAY: Freshman — FFA, Football, Perfect attendance; Sophomore — Football; Junior — Football, GBT, Perfect Attendance; Senior — Football — 1st Team Defense All-district, GBT, TCA.

RUTH ANN GIPE: Freshman — Basketball, Black and Gold Staff, FHA — FHA Service Award, Spanish club; Sophomore — Beta Club, English II Award, FHA, Band — Flag Corp, Home Ec. II Award, Honors Banquet, Spanish II Award; Sophomore — Beta Club, FHA — President, Golden Torch Staff, Honors Banquet, Leadership Award, Math Club, Photography Workshop, Powder Puff Football, S.A.D.D., Science Club; Senior — Beta Club, FHA — President, Golden Torch Staff, Herald Gazette "Hi Tide" Article, Math Club, Science Club, Tennis.

#### HOLLY GLIDEWELL

STEPHANIE GOODWIN: Freshman — Algebra I Contest 7th Place Regional, Beta Club, Black and Gold Staff, FHA, Honors Banquet, Spanish Club, Tennis; Sophomore — Beta Club, Class Treasurer, Golden Torch Staff, Golf, Honors Banquet, OEA — Intro. VOE President; Junior — Algebra II Contest, Beta Club, FCA, Girls' State, Golden Torch, Golf, Honors Banquet, Honors English III Award, Math Club, OEA — VOE I Award, 2nd Place Financial Assistant Regional Contest, State Convention Voting Delegate, Powder Puff Football, Science Club; Senior — Beta Club, FCA, Golden Torch Editor, Golf, Honors Banquet, Math Club, Outstanding Senior, Powder Puff Football, Science Club, Top Ten Percent.

CHRISTINA GRAVES: Freshman — Band — Flag Corp, FHA, Honors Banquet; Sophomore — Band — Flag Corp, Honors Banquet,

OEA; Junior — Band — Flag Corp, DECA, Math Club; Senior — Band, FHA, Math Club, TCA.

EDDIE GRAVES: Freshman — Beta Club, FFA, Spanish Club; Sophomore — Beta Club, FFA; Junior — Beta Club, DECA, FFA, Math Club, Science Club; Senior — Beta Club, OEA, Math Club, Top Ten Percent.

JANIE GRAVES: Freshman — Art Club, FHA, Perfect Attendance; Sophomore — Art Club, Band — Rifle Corp, FHA; Junior — Art Club, FHA, OEA; Senior — Art Club, Cheerleader, FHA.

CHRIS GREENE: Freshman — Art Club, FFA; Sophomore — Art Club, FFA; Junior — DECA — Treasurer, FFA, Math Club; Senior — FFA.

KAREN GRIFFIN: Freshman — Wrestling Team — Manager (Pleasant Valley, Penn.); Sophomore — Art Club; Junior — Art Club, Powder Puff Football; Senior — DECA — Reporter, FHA, OEA, Powder Puff Football.

JEFF HANKINS: Freshman — FFA; Sophomore — Art Club, Baseball; Junior — Art Club, Baseball, DECA, FCA; Senior — Baseball, FCA.

JENNIFER HARPER: Freshman — FHA, Spanish Club; Sophomore — FHA; Junior — FHA, OEA; Senior — FHA, OEA, TCA.

MISSY HARPER: Freshman — Art Club, FHA — Best Pledge; Sophomore — Band, FHA; Junior — Art Club, Band; Senior — Art Club, Band, TCA.

TODD HENSLEY: Freshman — Baseball, Football, Honors Banquet, Spanish Club; Sophomore — Baseball — All-district, Football, Honors Banquet, Geometry Contest; Junior — Baseball — MVP, Highest Battling Average, All-district, Boys' State Delegate, FCA, Football, Honors Banquet, Math Club, Science Club; Senior — Academic Decathlon, Baseball, FCA, Football — 2nd Team All-district, Honors Banquet, Math Club, Science Club, Top Ten Percent.

MICHELLE HICKERSON: Freshman — Band — Flag Corp, Beta Club, Cheerleader, FHA, Tennis; Sophomore — Band — Flag Corp, Beta Club, Cheerleader, Honors Banquet; Senior — FCA, Math Club, OEA.

PAULA HICKERSON: Freshman — Basketball, FHA; Sophomore — Basketball, Tennis, Junior — Basketball, Tennis; Senior — OEA, Tennis.

BILL HODGES: Freshman — Basketball, Class President, Football, Spanish Club, Tennis; Sophomore — Basketball, Football, Letterman's Club, Tennis; Junior — Basketball, FCA, Football, Tennis; Senior — Basketball, FCA, First Team All-District Football, Football, Math Club, Tennis, Most Athletic, American Legion Citizenship Award.

ROBBIE HOLMES: Freshman — Spanish Club; Sophomore — Art Club; Junior — DECA; Senior — DECA.

VICKIE JARRETT: Junior — Art Club, OEA; Senior — TCA.

LAQUISSA JOHNSON: Freshman — Black and Gold Staff, FHA, Perfect Attendance, Spanish Club; Sophomore — FHA, Perfect Attendance, OEA; Junior — Beta Club, OEA; Senior — Jackson Sun Teen Page Writer, OEA — Secretary, Outstanding Senior, Student Council.

TRINA JOHNSON: Junior — Art Club.

JEANNIE KENT: Freshman — FHA; Sophomore — OEA; Junior — DECA, OEA; Senior — DECA

BRENT KIMERY: Freshman — FFA — Greenhand Award, Livestock Judging, Sophomore — FFA — Chapter Farmer, Dairy Judging, Livestock Judging, Upper Division Skills Contest; Junior — DECA, FFA; Senior — DECA, Math Club, Tennessee High School Rodeo Association.

MICHAEL LEE LANGSTON: Freshman — Football, Golf, Spanish Club; Sophomore — Art Club, Football, Golf, Letterman's Club; Junior — DECA, FCA, Golf; Senior — FCA, Golf, Math Club.

ANGELA LEWIS: Freshman — Basketball, Black and Gold Staff, FHA, Spanish Club; Sophomore — OEA, Tennis; Junior — DECA — Secretary, Math Club, Science Club, Tennis; Senior — DECA — President, Math Club, Tennis, Wittiest.

MELINDA LITTLE: Freshman — Band, FHA; Sophomore — Band, FHA; Junior — Art Club, Band, FHA; Senior — Art Club, Band.

MELISSA LITTLE: Freshman — Basketball, FHA; Sophomore — Band, FHA; Junior — Art Club, Band, FHA; Senior — Art Club, Band, TCA.

COLIS LONG: Freshman — Black and Gold Staff, Honors Banquet, Perfect Attendance, Spanish Club; Sophomore — OEA; Junior — DECA — State Competitor; Senior — TCA — Vice-president, Coordinator of Leadership Development.

SABRINA MACKIN: Freshman — FHA; Sophomore — Art Club; Junior — Art Club, OEA 1 Senior — Art Club, FHA.

PAM MANCE: Freshman — Choir (Elkhart Central High School); Sophomore — Bazar Chorale; Junior — Concert Choir; Senior — TCA.

CORNELIUS MAYBERRY: Freshman — FFA, Football, Perfect Attendance; Sophomore — Football; Junior — Football, GBT; Senior — Football — 2nd Team All-district, GBT, TCA.

CRAIG McALEXANDER: Freshman — Art Club, FFA; Sophomore — FFA, FHA; Junior — Art Club; Senior — DECA.

STACEY MILLER: Freshman — FHA, Perfect Attendance; Sophomore — FHA, Perfect Attendance, OEA; Junior — OEA; Senior — OEA; Senior — Library Aide, OEA, TCA.

KEVIN MILLIGAN: Freshman — Baseball, Basketball, Beta Club, Perfect Attendance, Spanish Club; Sophomore — Baseball, Basketball, Beta Club, Letterman's Club, Perfect Attendance; Junior — Baseball, Basketball — Coca-Cola Basketball Award, Beta Club, Honors Banquet; Senior — Baseball, Most Improved Player, Basketball, Beta Club, Class Vice-president, FCA, Math Club; Senior —

Beta Club, FCA, Honors Banquet, Math Club, Science Club.

SHERRI MILLIGAN: Freshman — Beta Club, Cheerleader, FHA, Homecoming Representative; Sophomore — Beta Club, Golden Torch Staff, Varsity Basketball Cheerleader; Junior — Beta Club, DECA, FCA, Golden Torch Staff, Homecoming Representative, Marketing I Award, Math Club, OEA, Science Club, Football and Basketball Cheerleader; Senior — Beta Club, FCA, Math Club, OEA — President, Homecoming Representative, Science Club.

ANTHONY MOORE: Freshman — FFA — Greenhand Award, Football, Spanish Club, Sophomore — FFA; Junior — FFA, OEA; Senior — FHA, OEA.

GAVIN ORGAIN: Freshman — Beta Club, Black and Gold Staff, Honors Banquet, Spanish Club, Spanish I Award; Sophomore — Beta Club, Geometry Contest, Golden Torch Staff, Honors Banquet, Tennis Team; Junior — American Government Award, Beta Club, Golden Torch Staff, Honors Banquet, Math Club, Tennis — District Tennis Team; Senior — Art Club, Beta Club, Math Club — Treasurer, Science Club, Tennis, Top Ten Percent.

LORA PARNELL: Freshman — Band, Most Improved Freshman Band Student, Beta Club, FHA, Home Ec. I Award, Honors Banquet; Sophomore — Band, Beta Club — Secretary, FHA — Executive Council, Geometry Contest, Honors Banquet, Perfect Attendance, Student Council; Junior — Algebra II Award, Band, Beta Club — Treasurer, FHA — Vice-president, GC EMC Essay Winner, Girls' State Alternate, Honors Banquet, Math Club, Perfect Attendance, Science Club, Student Council — Treasurer; Senior — Band, Beta Club — Vice-president, Century III Leaders Scholarship State Semi-finalist, FHA — Vice-president, Honors Banquet, Math Club — Vice-president, Most Likely to Succeed, Outstanding Senior, Science Club — Vice-president, Student Council — Treasurer, Top Ten Percent, UTM Honor Band Alternate.

LISA PARTIN

ELDRED PETERSON: Freshman — Basketball, FFA, FHA; Sophomore — basketball; Junior — Basketball — Best Offensive Player, FHA, OEA; Senior — Basketball, TCA.

JOHN PRINCE: Freshman — Beta Club, FFA — Greenhand Award, Member of the Month, District Skills Team Champion, West Tn Skill Team Champion, Football, Honors Banquet, Spanish Club, Student Council; Sophomore — Beta Club, FFA — Bob Dodd Memorial Livestock Judging Award, Football, Golf, Honors Banquet, Letterman's Club, Student Council; Junior — Baseball, Beta Club — Secretary, Boys' State Delegate, Class President, FCA, Football, Honors Banquet, Math Club, Science Club, Student Council; Senior — Baseball, Beta Club — President, Class President, FCA, FFA, Football — Pepsi-Cola Leadership Award, Honorable Mention All-district, Honors Banquet, Math Club, Mr. PHS, National Association of Secondary Schools Principles' Leadership Scholarship Nominee, Outstanding Senior, Science Club — President, Student Council — Sgt. at Arms, Top Ten Percent.

STEVE PRINCE: Freshman — Band — Jr. High All-West Honor Band, Quad State Honor Band, Solo and Ensemble Superior Rating, Jazz and; Sophomore — Band — All-West Honor Band, Jazz Band, Solo and Ensemble Superior Rating, OEA — 3rd place Job Interview, Tennis; Junior — Band — Quad State Honor Band, Solo and Ensemble Superior Rating, Boy's State Alternate, UTM Honor Band; Senior — Band — UTM Honor Band, Solo and Ensemble Superior Rating, Second Lieutenant, Class Vice-President, Math Club, Most Enthusiastic, Outstanding Senior — Science Club.

LISA RANGEL: Freshman — Band — Flag Corp, Basketball, FHA; Sophomore — Band — Flag Corp, FHA, OEA; Junior — Art Club, DECA, FHA; Senior — Beta Club, DECA — Secretary, FHA — Advisory Council.

MELISSA RAWDON: Freshman — Band; Sophomore — Band; Junior — Band; Senior — Art Club, FHA, OEA, TCA.

DAPHYNE RAY: Freshman — Band, Black and Gold Staff; Sophomore — Band; Junior — Band, OEA; Senior — Band, OEA — Treasurer.

DALE REASONS: Freshman — Art Club, FFA; Sophomore — Art Club, FFA; Junior — FFA — 2nd Vice-President; Senior — GBT.

JAY RICHARDSON: Freshman — Football, Spanish Club; Sophomore — OEA; Junior — Art Club, DECA, GBT; Senior — DECA.

GREG RINKS: Freshman — FFA; Sophomore — Art Club, Baseball; Junior — Baseball — Most Improved Player, GBT; Senior — Baseball, GBT.

GEORGE ROBINSON: Freshman — FFA; Junior — GBT; Senior — GBT.

MARY ROBINSON: Senior — TCA — Coordinator for Social Affairs.

AMANDA RUSSELL: Freshman — Art Club, Beta Club; Sophomore — Beta Club, OEA; Junior — Beta Club, OEA, Powder Puff Football; Senior — DECA — Treasurer, OEA — Parliamentarian, Powder Puff Football.

MIYOSHI RUSSELL: Freshman — Cheerleader, FHA, Perfect Attendance, Sophomore — Cheerleader, OEA, Perfect Attendance; Junior — Cheerleader — Cooperation Award, OEA; Senior — Most Enthusiastic, OEA.

RODNEY RUSSELL: Freshman — Basketball, FFA, Perfect Attendance, Junior — Perfect Attendance, GBT; Senior — GBT, TCA.

JASON SCOTT: Freshman — Beta Club, FFA — Greenhand Award, Chapter Creed Award, 2nd Place District Creed Contest, February Member of the Month, Livestock Judging, Football, Honors Banquet; Sophomore — Art Club — 1st place Art Contest — Drawing, Beta Club, FFA, Honors Banquet, Perfect Attendance; Junior — Academic Decathlon, Beta Club, 1st place Art Contest — Drawing, FHA, Honors Banquet, Math Club, Science Club, Senior — Academic Decathlon, Art Club, Drama Club, Golden Torch Staff — Art and Layouts, Honors Banquet, Most Talented.

BRAD SCRUGGS: Freshman — FFA; Sophomore — Class Vice-president, FFA; Junior — DECA, FFA; Senior — DECA.

CRYSTAL SHEPHERD: Freshman — FHA, Spanish Club; Sophomore — Beta Club, FHA; Junior — Beta Club, FHA — Secretary, Home Ec. III Award, Math Club, OEA, Intro. VOE Award; Senior — Beta Club, FHA — 2nd Vice-president, Math Club, OEA.

SUSAN SISK: Freshman — Band — Flag Corp, Basketball, Beta Club, Tennis; Sophomore — Band — Flag Corp, Basketball, Beta Club, Golden Torch Staff, Honors Banquet, Tennis; Junior — Band — Flag Corp, Basketball, Beta Club, Class Treasurer, FCA — Secretary, Girls' State Delegate, Golden Torch Staff, Homecoming Representative, Honors Banquet, Math Club, Powder Puff Football, Science

Club, Tennis; Senior — Band — Flag Corp, Basketball, Beta Club, Class Treasurer, FCA — President, Honors Banquet, Homecoming Queen, Math Club — Secretary, Miss PHS, Powder Puff Football, Outstanding Senior, Science Club — Treasurer, Tennis, Top Ten Percent.

JOEL SMITH: Freshman — Art Club, Football, Spanish Club; Sophomore — Art Club, Baseball, Football, Letterman's Club; Junior — Baseball, Beta Club, FCA, Football — Most Improved Player, Honors Banquet, Math Club, Science Club; Senior — Baseball, FCA, Football — Honorable Mention All — District, Honors Banquet, Math Club.

GARY SWIFT: Freshman — Basketball, FFA, Perfect Attendance; Sophomore — Basketball; Junior — Basketball, GBT, Perfect Attendance; Senior — Basketball, GBT, TCA.

JOEY TALLEY: Freshman — Special Olympics; Sophomore — Special Olympics; Junior — Special Olympics; Senior — Special Olympics.

CHRIS TEMPLE: Freshman — FFA — Greenhand Award, Football, Tennis; Sophomore — FFA, Football, Tennis; Junior — Art Club, GBT, Tennis; Senior — Art Club, GBT, Tennis.

TOM THEDFORD: Freshman — Football (Elk Grove High School); Sophomore — Football, Wrestling; Senior — FFA.

DENISE THETFORD: Freshman-Basketball Manager, Spanish Club; Sophomore — Golden Torch Staff, Spanish Contest — Union University; Junior — Black and Gold Staff, Library Aide, OEA; Senior — Art Club, OEA.

REBECCA THOMAS: Freshman — FHA; Sophomore — FHA, OEA; Junior — FHA, Senior — FHA — Advisory Council, TCA.

CHUCK THOMPSON: Freshman — Basketball, Beta Club, Football; Sophomore — Basketball, Beta Club, Golf — Most Improved Player; Junior — Basketball, Golf, Math Club; Senior — Golf, Math Club, Most Original, Science Club.

DENISE THOMPSON: Freshman — Band — Solo and Ensemble Superior Rating, Black and Gold Staff, Cheerleader, FHA; Sophomore — Football cheerleader, Golden Torch Staff, OEA — Typing and Related I Contest 2nd place, Intro, VOE Award, Letterman's Club, Tennis; Junior — FCA, Football Cheerleader, Golden Torch Staff, Honors Banquet, Math Club, OEA — Job Interview I Contest — 2nd place, State Convention Voting Delegate, Science Club; Senior — Beta Club, FCA, Golden Torch Staff — Copy Editor, Golf Team, Math Club, Science Club.

PATRICIA TRULL: Freshman — Beta Club, English I Award, FHA, Perfect Attendance; Sophomore — Beta Club, OEA, Perfect Attendance; Junior — Beta Club, DECA, Math Club, OEA, Perfect Attendance, Science Club; Senior — Beta Club, DECA, Math Club, OEA — Vice-president, Science Club, Top Ten Percent.

AMY R. TURNER: Freshman — Annual Staff, Spanish Club, TOEC, Youth for Christ Club; Sophomore — FHA; Junior — DECA, English III Award, OEA; Senior — FHA.

MELISSA TURNER: Freshman — Band — Flag Corp, FHA; Sophomore — Band-Flag Corp, OEA; Junior — DECA, Most Improved Junior Award, OEA; Senior — OEA — Historian.

SHERRY TYNER: Freshman — Band, Black and Gold Staff, FHA; Sophomore — Band, OEA; Junior — DECA, FHA; Senior — DECA — Parliamentarian, FHA, OEA.

SHEILA VIRGINIA: Junior — OEA; Senior — Art Club, OEA.

COURTNEY WADE: Freshman — Basketball, FFA; Sophomore — Basketball; Junior — Art Club; Senior — Art Club.

KIM WADE: Freshman — Band — Flag Corp, FHA, Honors Banquet, Student Council, Tennis; Sophomore — Band — Flag Corp, Beta Club, Honors Banquet, Tennis; Junior — Beta Club, DECA, Golden Torch Staff, Honors Banquet, Math Club, OEA; Senior — Beta Club, Math Club, Science Club.

LINDA WADE: Freshman — Special Olympics; Sophomore — Art Club, Special Olympics; Junior — Art Club, Special Olympics; Senior-Special Olympics.

MICHAEL WALLSMITH: Freshman — Basketball, FFA — Greenhand Award, Perfect Attendance; Sophomore — Baseball, Basketball, FFA; Junior — Baseball, FCA, Math Club, OEA, Perfect Attendance, Science Club; Senior — Baseball, FCA, Math Club.

RACHELLE WARD: Sophomore — Homecoming Representative; Senior — TCA — President.

WENDY WARREN: Freshman — FHA; Sophomore — FHA, Citizenship Award; Junior — FHA, OEA.

VERONICA WELCH: Freshman — Basketball; Sophomore — Basketball, Junior — Art Club, Basketball; Senior — Art Club, Most Athletic.

#### ALYCE WILLIAMS

CAROL WILSON: Freshman — FHA, Special Olympics; Sophomore — FHA, Special Olympics, Junior — Art Club, FHA, Special Olympics; Senior — Art Club, FHA, Special Olympics.

CORY WILSON: Freshman — Art Club, Basketball, Football; Sophomore — Art Club, Football; Junior — GBT; Senior — GBT.

MELISSA WILSON: Freshman — Band — Rifle Corp, Cheerleader, FHA; Sophomore — Band — Rifle Corp, FHA; Junior — Band — Rifle Corp, Senior — Cheerleader, FHA, TCA.

CHARLTON ZARECOR: Freshman — Football, Spanish Club; Sophomore — Football, Tennis; Junior — FCA, Football, Tennis; Senior — FCA, Football — Special Teams Award, Math Club, Science Club, Tennis.



Autographs

Autographe

Autographs

Autographe



